

---

# The Small-Circle Reconstruction in Palaeomagnetism

Martin Waldhör, Inst. für Geowissenschaften, Tübingen, Germany

Contact: martin.waldhoer@uni-tuebingen.de

## Abstract

Through tilting, in-situ remanences become distributed on a small circle (*remanence small circle*), which is perpendicular to the tilt axis. Small-circle distributions can be observed in folded sequences, single sites and single specimens. This aspect and its consequences for the interpretation of palaeomagnetic remanences obviously have not been discovered before, though it is a common property of in-situ remanences in folded sequences. The position of a remanence small circle is a function of the acquisition field ( $D/I$ ) and the trend of the tilt axis. With the assumption that tilting and block rotation occur around horizontal and vertical axes, tilting and block rotation of an in-situ remanence can be reconstructed. This *small-circle reconstruction* is ambiguous, but equivalent reconstructions can be resolved by additional information, e.g. upright or overturned bedding, results from adjacent sites and local geology. From originally E-W or close to E-W tilted sites, the inclination of the palaeofield can be estimated, thus, providing an alternative approach to the palaeoinclination, no matter if remanences are primary or secondary. Finally, if in-situ remanence components of one site have recorded different increments of the displacement, they directly give a path of displacement. The small-circle concept provides a comprehensive approach to the interpretation of palaeomagnetic remanences. The conventional aspects of palaeomagnetism such as the two-dimensional Gaussian distribution, Fisher statistics and bedding correction, are fully incorporated. The new method allows the analysis of a much broader range of data and is the key to the use of secondary remanences. Data which up to now had to be discarded as statistically non-significant or meaningless, can now be interpreted.

## 1. The Small-Circle Concept

### 1.1 Introduction

Palaeomagnetic analysis and interpretation almost exclusively focus on bedding corrected remanence directions. Bedding (or tilt) correction tilts the rock layer with its remanence vector back to the horizontal around the strike of the bedding plane. If the remanence is primary, it will be restored to its original inclination and can be interpreted in terms of N-S movement and block rotation. If secondary, tilt correction gives a meaningless result. Secondary in-situ remanences have been interpreted only, if the remanences were acquired after folding was completed.

This procedure overlooks two basic aspects of in-situ remanences:

- (a) In-situ remanences reflect a true net amount of rotational displacement since their acquisition.
- (b) The distribution of in-situ remanences is related to the direction, angle and sense of tilting.

The following concept outlines how tilting and block rotation control the distribution of in-situ remanences. With a known acquisition field, this relationship allows tectonic rotations to be extracted from in-situ remanences alone. The concept bases on two assumptions which in nature mostly are reasonable and also are part of the established data processing and interpretation procedure in palaeomagnetism:

- (a) Tilting occurs around horizontal axes.
- (b) Block rotation occurs around vertical axes.

These assumptions are certainly valid in general for deformation at shallow depth and moderate metamorphism. Possible exceptions such as deformation in shear zones have to be avoided by adequate sampling.

The fold test according to McFadden (1990) bases on a correlation of remanence direction and tectonic tilt, but does not denote the small-circle distribution of remanences due to tectonic displacement. Mardia & Gadsden (1977) report a possible small-circle distribution of palaeomagnetic directions, but not related to tectonic displacement. Statistical treatment of small-circle distributions has been described by Mardia & Gadsden (1977), Gray et al. (1980) and Fisher et al. (1987). MacDonald (1980) discusses net tectonic rotation and tilt correction in palaeomagnetism. He notes that palaeomagnetic poles (in bedding coordinates) can have a small-circle distribution, but attributes this to an inappropriate tilt correction. Ménard & Rochette (1992) and Crouzet et al. (1996) report the scatter of secondary remanences due to rotational displacement around a horizontal axis, but do not note their obvious small-circle distribution. They determine tilt angles between the remanences and an expected reference palaeofield using a projection method not described in detail.

Therefore, it seems the small-circle distribution of in-situ remanences due to tectonic displacement and i.e. the consequences on palaeomagnetic methodology have not been recognised before.

## 1.2 Terminology and Conventions

The conventions used from here on are illustrated in Fig. 1.1. *Tilting* will refer to rotation around horizontal axes and *block rotation* will refer to rotation around vertical axes. *Displacement* means rotational rigid body displacement including *tilting* and *block rotation*. The term *displacement path* denotes the path of these rotations. The term *tilting direction* denotes the projection of the *dip vector* of a layer to the horizontal x-y plane. The tilting direction is perpendicular to the corresponding tilt axis. The Cartesian coordinate system and the rotation senses will be defined as shown in Fig. 1.1. The trend of the tilt axis varies between  $0^\circ$  and  $180^\circ$ . The rotation angle is clockwise negative and counterclockwise positive when viewed from the sphere centre (downwards for block rotation). The angular distance  $d$  (defined in the next section) is positive to the

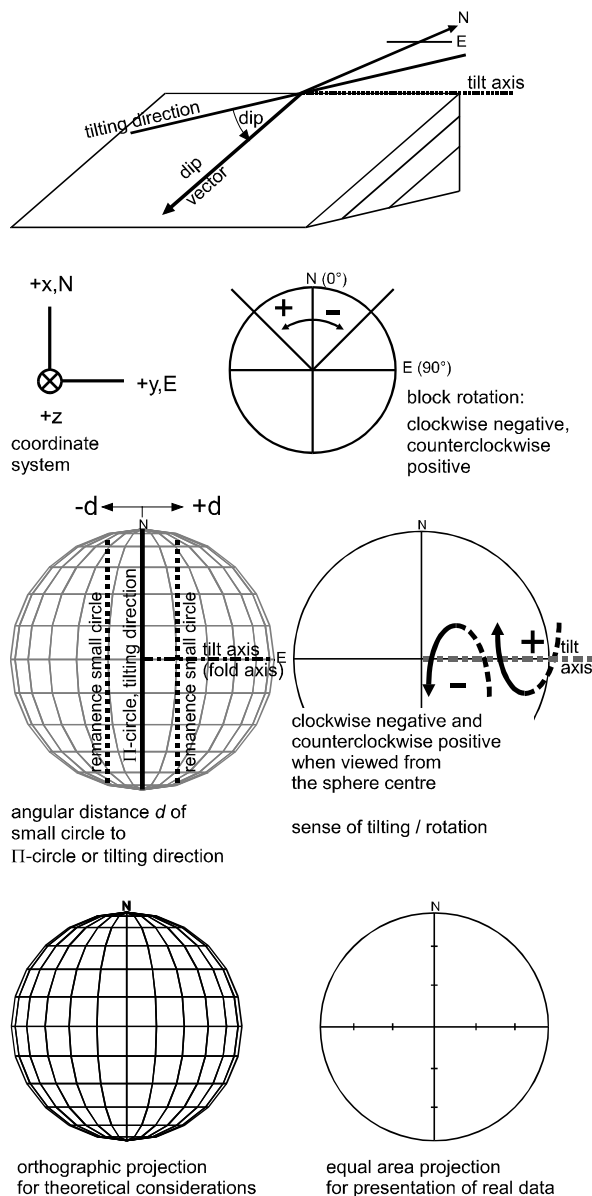

right of the II-circle (mean great circle for a distribution of bedding poles) or tilting direction (in the case of one bedding pole), and negative to the left of it. Theoretical considerations will always be presented in orthographic projections, where small circles parallel to the z-axis show up as straight lines. Real data will be shown in equal-area projections.

**Fig. 1.1: Conventions for coordinate system, block rotation, tilting, rotation senses and projections. The term *tilting direction* denotes the projection of the *dip vector* of a layer to the horizontal plane. The trend of the tilt axis varies between  $0^\circ$  and  $180^\circ$ . Rotations (tilting and block rotation) are clockwise negative and counterclockwise positive, when viewed from the sphere centre (downwards for block rotation). For graphical presentation of theoretical considerations, the orthographic projection will be used. Real data will be shown in equal-area projections.**

Further on, four types of palaeomagnetic data will be under consideration. To avoid confusion, the following terms will be used:

- *Site mean* as calculated by Fisher statistics (Fisher 1953) for a number of single specimen remanence components.
- *Remanence component* from a single specimen obtained by component analysis.
- *Remanence direction* as measured at a single step during the demagnetisation of single specimens (raw data).

- *Differential vector* as calculated from the remanence directions of subsequent steps during demagnetisation.

*Remanence* will be used as a general term encompassing all these kinds of directional palaeomagnetic data.  $D_{bc}/I_{bc}$  and  $D_{is}/I_{is}$  denote declination and inclination in bedding coordinates and in-situ coordinates, respectively. A glossary at the end of this thesis lists the most relevant and partly new terms as well as frequently used abbreviations.

### 1.3 The Small-Circle Distribution of In-Situ Remanences

Palaeomagnetic remanences in rocks are thought to be acquired in a geomagnetic dipole field. Assuming an axial geocentric dipole and averaged on secular variation, this field has a zero declination and an inclination as a function of the latitude. Tilting and block rotation will rotate the in-situ remanence away from the original position. Primary remanences undergo all sequences of displacement, secondary remanences only that part which occurs after their acquisition.

The control on the distribution of in-situ remanences by the tilting direction (or tilt axis) and the field of acquisition is illustrated in Fig. 1.2. In a three-dimensional perspective view, Fig. 1.2a shows remanence directions acquired at a field of  $I_{acq} = 60^\circ$ , that rotate on small circles around three different tilt axes. Each remanence small circle is perpendicular to its corresponding tilt axis. For each field polarity, one small circle exists (Fig. 1.2b-d). Both small circles are parallel to the tilting direction. For a given field inclination, the angular distance  $d$  of the small circles to the tilting direction is a function of the trend of the tilt axis. N-S oriented tilting produces a zero distance, E-W oriented tilting the largest distance.

The trend of the tilt axis  $t$  and the angular distance  $d$  as a fraction of the radius of the sphere ( $r = 1$ ) are given by:

$$d = \cos t \cos I_{acq} \quad (1)$$

$t$  trend of the tilt axis;  $I_{acq}$  inclination of the acquisition field

Hence, with a known acquisition field, the original tilt axis can be determined from the angular distance  $d$ . A subsequent block rotation can be inferred by comparison of the calculated tilt axis with the present one.

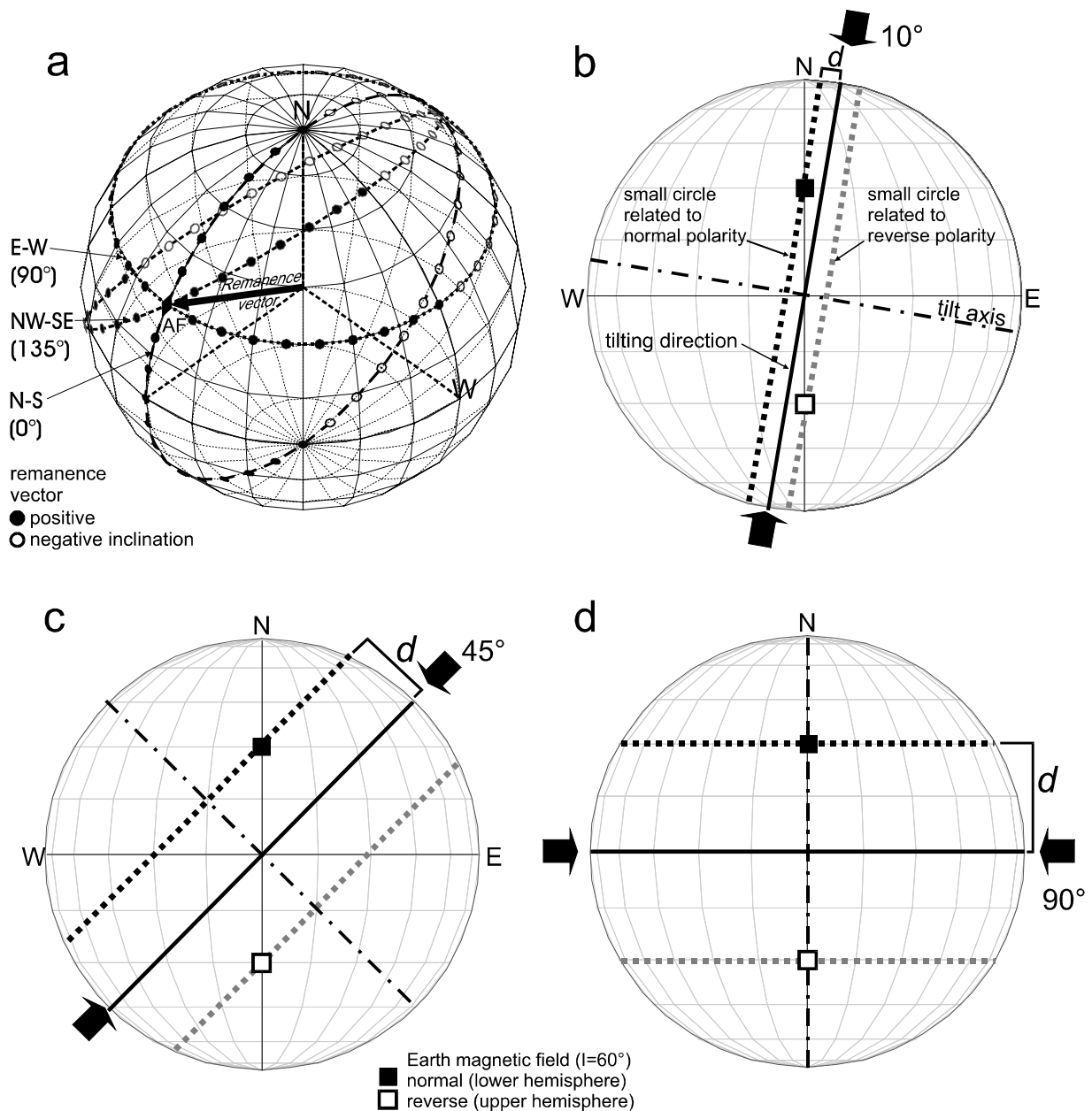

**Fig. 1.2: Rotation of remanence directions on small circles by tilting. Acquisition field at  $D/I = 0^\circ/60^\circ$  (assumed to be normal) and reverse. (a) Perspective view of a sphere showing rotation of remanence directions in  $10^\circ$  steps. Hidden lines are dashed. Tilting directions are N-S ( $0^\circ$ ), NW-SE ( $135^\circ$ ) and E-W ( $90^\circ$ ) oriented. AF: Normal acquisition field with  $I_{acq} = 60^\circ$ . Note that the hemisphere of the positive inclination (lower hemisphere in equal-area plots) is rotated to the front. (b) Orthographic projection showing the two small circles for  $10^\circ$  oriented tilting, one related to normal, the other to reverse field polarity. (c)  $45^\circ$  (NE-SW) tilting. (d)  $90^\circ$  (E-W) tilting. For a given field inclination  $I_{acq}$ , the angular distance  $d$  between the small circles and the tilting direction is related to the direction of tilting.**

The positions of in-situ remanences on a small circle are further controlled by the angle and sense of tilting. Fig. 1.3 illustrates four possible constellations. For a primary remanence the dip angle of the layer and the tilt angle of the remanence direction coincide (Fig. 1.3a). The remanence will be restored to its original position by 100% untilting. A secondary remanence underwent only part of the tilting (Fig. 1.3b) and will be restored by  $<100\%$  untilting. The situation in Fig. 1.3c implies that bedding is overturned. A negative percentage of untilting is required. The constellation in Fig. 1.3d can be explained in two ways. If tilting is allowed only in one sense, its angle must have exceeded  $180^\circ$ . The other solution is tilting first in one sense and then back in the opposite. If tilted sufficiently, remanences can change the hemisphere. This has to be considered, when a polarity is to be attributed to an in-situ remanence.

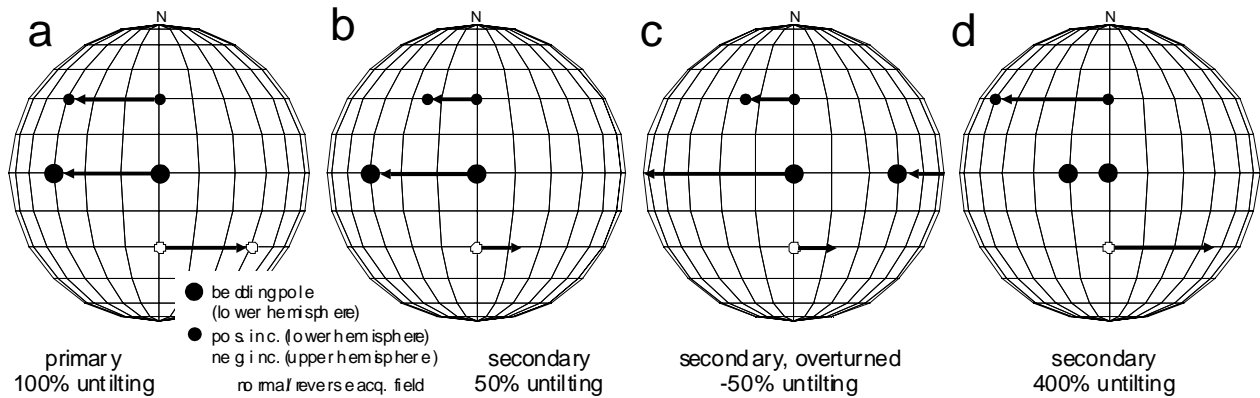

**Fig. 1.3: Comparison of bedding and remanence with respect to the rotation sense for E-W tilting. Normal and reverse acquisition field is shown for  $I_{acq} = 60^\circ$ . Percentage of untilting refers to the actual dip assumed to be upright. (a) A primary remanence undergoes the whole tilting and can be restored by 100% untilting (=angle of dip). (b) A secondary remanence acquired at 50% tilting. (c) A secondary remanence of an overturned layer requiring -50% untilting, leading to a steeper dip of the layer. (d) Untilting of the remanence direction exceeds the dip of bedding but has the same sense. This can be explained by either more than  $180^\circ$  of net tilting of the layer in one sense or tilting first in one and then back in the opposite sense. Real examples for this situation will be shown behind. Note that remanences can change the hemisphere through tilting.**

Hence, tilting back until the reference inclination is achieved gives the stage of tilting where a remanence direction has been acquired. Comparison of the in-situ remanence with the bedding allows the identification of upright and overturned layers and gives information about the process of folding.

## 1.4 Examples

The following examples show small-circle distributions of in-situ remanences on several scales. All data are from this work and will be discussed in detail in sections 2 and 3.

### 1.4.1 Small-Circle Distribution within a Folded Sequence

Fig. 1.4 shows 107 remanence components from 12 sites in a unidirectionally folded sequence. The bedding poles define a  $\Pi$ -circle which is nearly perpendicular (plunge of fold axis of  $1^\circ$ ). The fold test for this data set (see section 2) clearly shows a secondary character of the palaeoremanences.

The distribution of the in-situ remanence components (Fig. 1.4b) can be explained by a mean small circle parallel to the  $\Pi$ -circle of the bedding poles. The distribution around this small circle is broad, as well as the distribution of the bedding poles. As long as this is caused by a second, perpendicular phase of folding or initial heterogeneity in tilting, the position of the mean small circle will not be affected. All remanence components seem to originate from a normal acquisition field belonging to a small circle of normal polarity. With an assumed acquisition field of  $D/I = 10^\circ/55^\circ$  and the azimuth of the  $\Pi$ -circle as tilting direction, the whole sequence most probably experienced a counterclockwise block rotation of about  $20^\circ$ . However, this amount of rotation is an average over the whole sequence. Variations in tilting as well as possible block rotations between the sites, as might be supposed from the distribution of the bedding poles, are not resolved. This can be accounted for by considering the single sites with their tilt axes in the same way. As in the bedding correction of palaeomagnetic data, it is assumed that the tilt occurred around a horizontal axis.

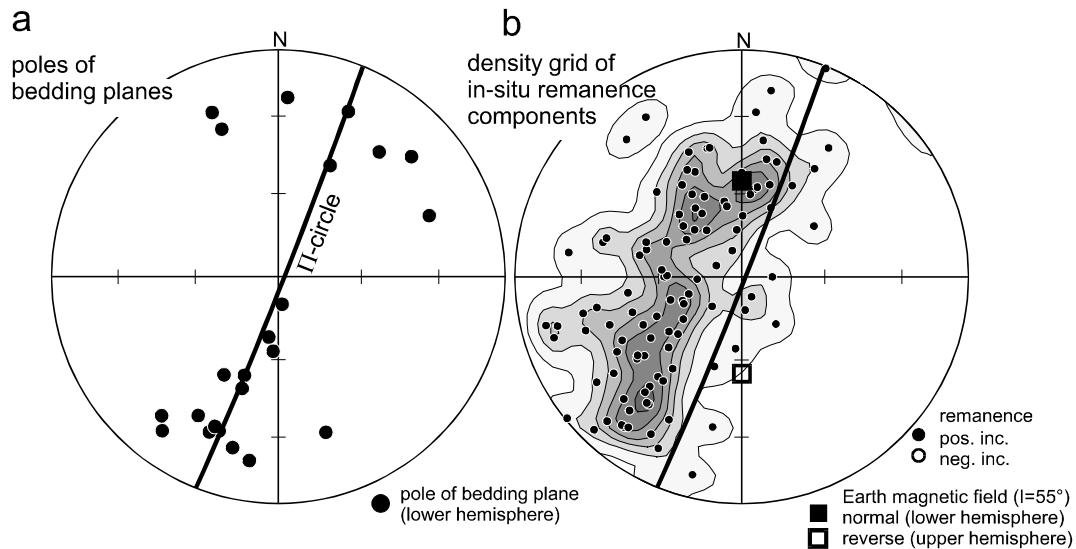

**Fig. 1.4:** Example of a data set of 12 sites in a unidirectionally folded sequence. (a) Bedding poles and  $\Pi$ -circle. (b) Density grid of 107 single in-situ remanence components in in-situ coordinates (positive inclination on lower hemisphere). Distribution is around a mean small circle parallel to the  $\Pi$ -circle of the bedding poles (thick line). Assuming an acquisition field of  $D/I = 10^\circ/55^\circ$ , the folded sequence most probably underwent an average counterclockwise rotation of about  $20^\circ$ . Detailed discussion in section 3.

#### 1.4.2 Small-Circle Distribution in Single Sites

Palaeomagnetism uses Fisher statistics (Fisher 1953) to calculate a mean value for a distribution and to estimate whether this mean value is statistically significant. Fisher statistics assume that the remanence vectors represent a two-dimensional Gaussian distribution (Fisher distribution) on a sphere due to secular variation of the Earth's magnetic field and/or non-systematic errors.

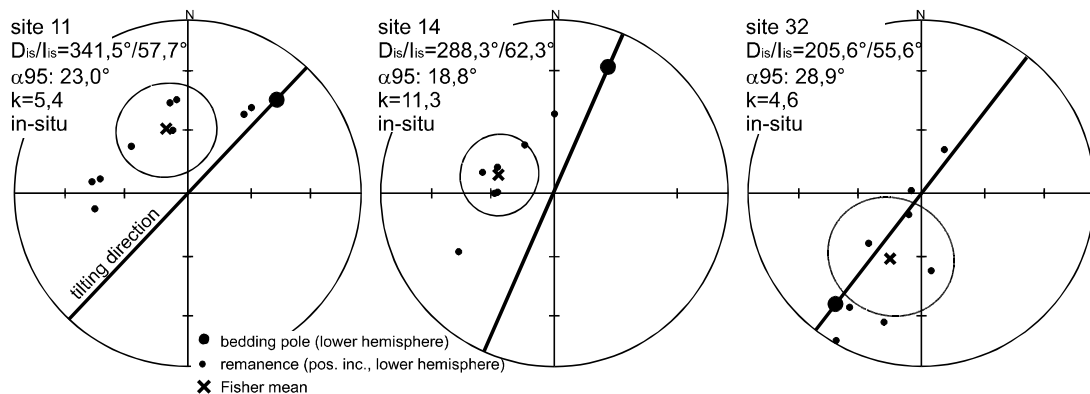

**Fig. 1.5:** Small-circle distributions of in-situ remanence components in single sites. Distribution is on a small circle roughly parallel to the corresponding tilting direction. Components obviously have different ages recording different increments of displacement. Each site was taken from a close succession of layers with the bedding as indicated. Specimens of each site are only a few metres apart. Fisher statistics give invalid means. Note that bedding in sites 11 and 14 is most probably overturned and in site 32 upright.

If the rock is rotated during the time interval of remanence acquisition, the remanences become distributed on a small circle, and application of Fisher statistics is no more valid. Examples for small-circle distributions of remanence components in single sites are shown in Fig. 1.6. Using Fisher statistics, sites 11 and 32 would be discarded because of a precision parameter  $k$  below 10. The remanence components in the sites

11, 14 and 32 (Fig. 1.5) obviously do not have a Fisher distribution. Acquired at different stages of tilting, they represent a magnetic record of tectonic displacement, thus defining a displacement path.

### 1.4.3 Small-Circle Distributions during Demagnetisation of Single Specimens

Small-circle distributions of remanences can even be observed in single specimens during stepwise demagnetisation. Fig. 1.6 depicts the demagnetisation behaviour of several specimens (Jurassic limestones, see section 3).

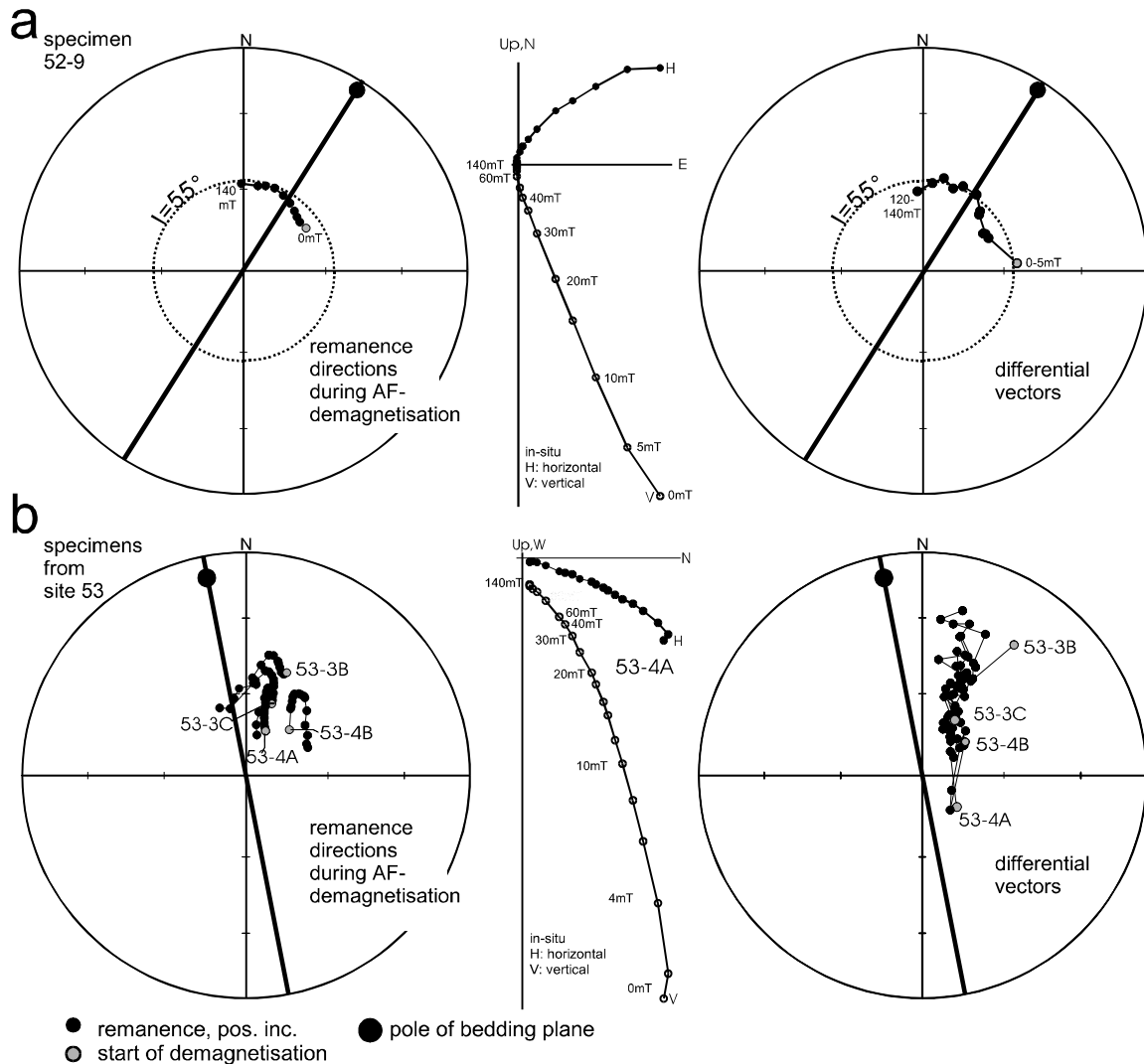

**Fig. 1.6: Small-circle distributions of remanences in single specimens during AF-demagnetisation. Demagnetisation behaviour in equal-area plots demonstrated by the remanence directions (sum vectors, left), the differential vectors (right) and the Zijderveld plot (middle). (a) The differential vectors during demagnetisation seem to follow a horizontal small circle of about  $I = 55^\circ$ . This behaviour requires at least three different remanence components to define the small circle. Note that the lowest-coercive component is the oldest, because it records most displacement. (b) Four specimens from the nearby site 53. Differential vectors during demagnetisation move on small circles roughly parallel to the tilting direction, hence are a consequence of tilting. A reversal of the tilting sense has occurred (better reflected by the remanence directions). Tilting as recorded has been first to the north and then back to the south. For discussion see text and section 3.**

The overall trend of block rotation in the surroundings is clockwise up to about  $-60^\circ$ . All specimens of this lithology exhibit a very well-defined and stable demagnetisation path. This permits the calculation of differential vectors between the measured remanence directions of the single demagnetisation steps.



Differential vectors in Fig. 1.6a follow a horizontal small circle of approximately  $I = 55^\circ$ . At least three different remanence components must be present to define the horizontal small circle. Alternatively, it is possible that the remanences are not composed of a few components only, but constitute a continuous or partly continuous record, showing as much components as have been sampled by the demagnetisation steps. This would imply a steady remanence acquisition in the course of tectonic displacement, rather than the acquisition of single discrete components. Then, the specimens in Fig. 1.6a would represent a continuous magnetic record of a clockwise block rotation. Surprisingly, the lowest-coercive component reflects the highest rotation and thus must be oldest. The fold tests indicate that an overall primary character of the remanences has not been preserved. However, as will be shown behind, some primary remanences are likely to have persisted in these rocks. Overprinting did not add the new components to the existing remanence, but replaced them. It seems the old magnetic record fades out while the new one is printed over, very much like overwriting a magnetic tape. This in turn supports the concept of a continuous remanence acquisition.

The differential vectors of the four specimens from the nearby site 53 (Fig. 1.6b) move mostly on a vertical small circle parallel to the tilting direction, and thus are clearly related to tilting. As before, at least three different remanence components are necessary to define the small circle. Alternatively, a steady remanence acquisition might have performed, giving a continuous record of tilting. If interpreted in this way, the demagnetisation behaviour reflects a reversal of the tilting sense. Tilting as recorded has been first to the north and then back to the south. This is further confirmed by the reconstruction of the site means of this site, as will be seen in section 3.

### ***1.5 Reconstruction of Small-Circle Distributions and Ambiguity***

The purpose of reconstruction is to obtain the angles of tilting and block rotation of an in-situ remanence, and to infer the path of displacement. Fig. 1.7 introduces the basic steps of reconstruction for the two extreme cases of N-S and E-W tilting. Both data sets underwent clockwise block rotation by  $-30^\circ$ . Reconstruction is done by tilting back the remanence until it reaches the inclination of the assumed acquisition field. This is given at the intersection of the remanence small circle with the small circle of constant field inclination. The angle of block rotation results from the difference between the declination of the reconstructed position and the declination of the reference field. For N-S tilting (Fig. 1.7a) the remanence small circles and the tilting direction coincide, implying that the angle of block rotation determined is independent from the inclination of the acquisition field. In this case, a wrong assumption of the inclination will not affect the block rotation determined. When the distance between the small and great circles becomes larger, reconstruction gets more sensitive to a variation of the inclination of the acquisition field. E-W tilting is most sensitive (Fig. 1.7b). In practice, variation of the field inclination within a range of  $5^\circ$  around the true value will not affect the results significantly. In most areas, the palaeofield is known within this range from the APWP, and thus reasonable assumptions can be made. Moreover, in Alpine and Himalayan fold belts, N-S convergence is common, which is the most insensitive case for the reconstruction of the declination.

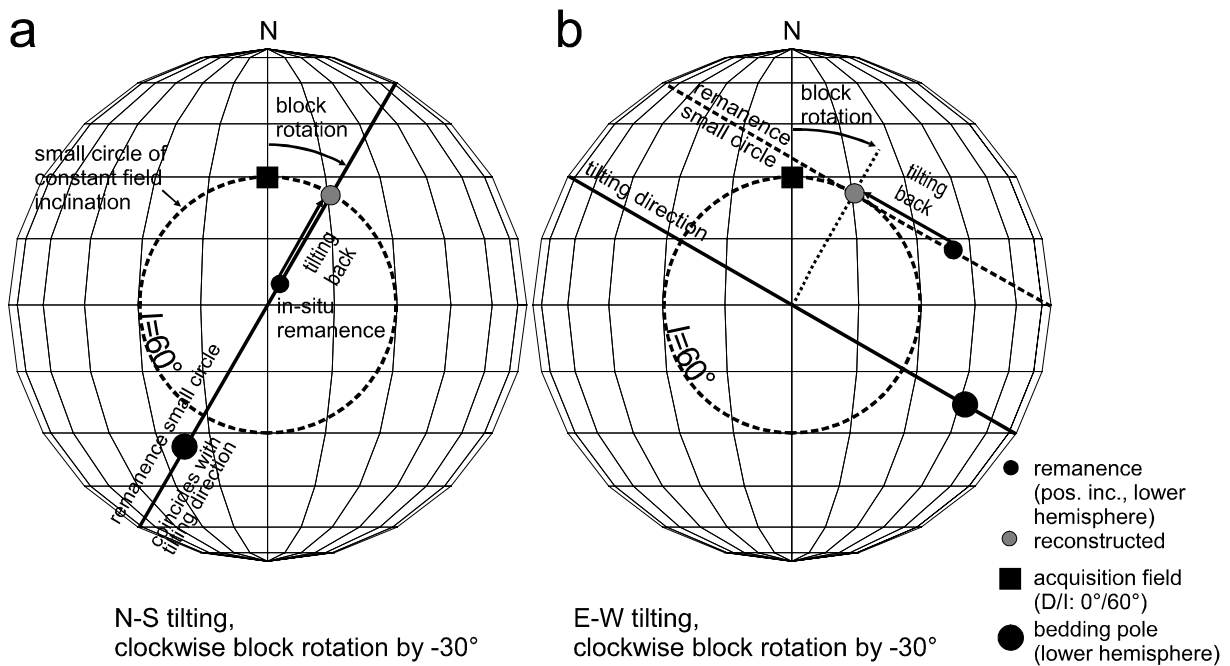
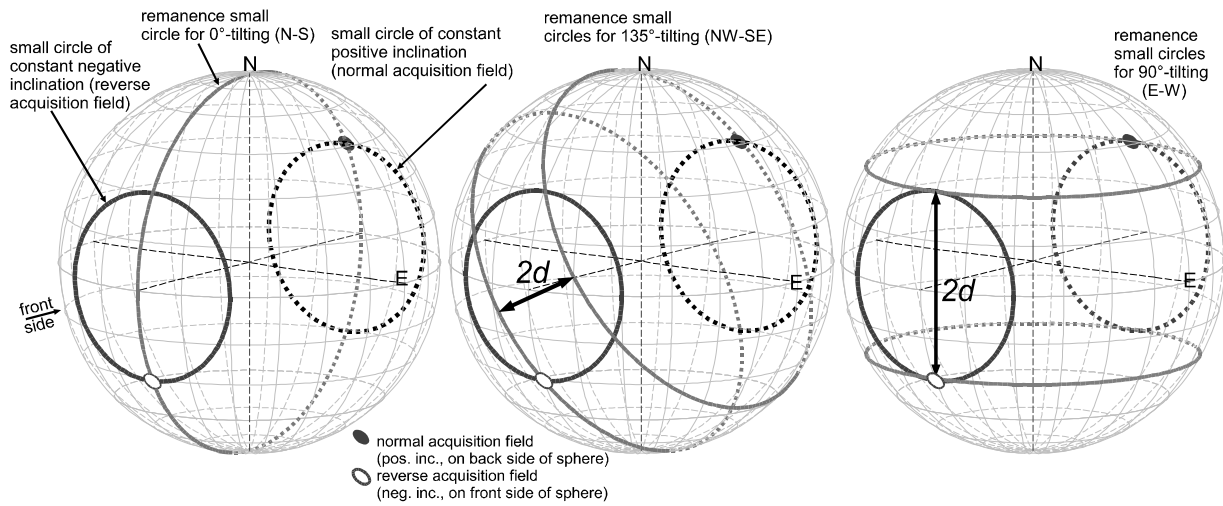

**Fig. 1.7: Reconstruction of  $-30^\circ$  clockwise block-rotated secondary in-situ remanences. (a) N-S tilting with zero distance between remanence small circle and tilting direction. (b) E-W tilting with largest distance of remanence small circles to tilting direction. The reconstructed position is at the intersection of the remanence small circle with the small circle of constant field inclination. For N-S tilting where remanence small circles and tilting direction coincide, the angle of block rotation is independent from the inclination of the acquisition field.**

Up to this point, only positive inclinations on the lower hemisphere coming from a normal polarity field have been examined. However, both field polarities have to be considered as possible origins. Fig. 1.8 shows a three-dimensional representation of this problem. Remanence small circles are shown for  $0^\circ$  (N-S),  $135^\circ$  (NW-SE) and  $90^\circ$  (E-W) oriented tilting. The small circles of constant field inclination are for  $I_{acq} = \pm 60^\circ$ . Apart from E-W tilted remanences having only two touching intersections, each remanence small circle has four intersections, two with the small circle of positive inclination, and two with the small circle of negative inclination.

Hence, up to four direct reconstructions (tilting/block rotation  $< 180^\circ$ ) exist for each remanence small circle. While at N-S tilting a block rotation of  $180^\circ$  is needed to exchange the intersection points, this angle decreases with the distance  $d$  of the remanence small circle and gets zero at the maximum distance  $\cos I_{acq}$ . In practice, this means that at N-S tilting, the possible reconstructions are easier to distinguish upon probability. In the case of tilting close to E-W, equivalent reconstructions come close to each other and are more difficult to assess.

Thus, for each angular distance  $d$  there are two reconstructed tilting directions. Each tilting direction can be related either to the normal polarity or the reverse polarity field, giving two possible block rotations for each tilting direction.



**Fig. 1.8: Three-dimensional views of a sphere with the hidden lines dashed. Small circles of constant field inclination for a normal and reverse acquisition field at  $I_{acq} = \pm 60^\circ$ . Full circle at backside: normal polarity field, open circle on front side: reverse polarity field. Remanence small circles for normal and reverse polarity are shown for  $0^\circ$  (N-S),  $135^\circ$  (NW-SE) and  $90^\circ$  (E-W) oriented tilting. Except for the maximum angular distance  $d$  in the case of E-W tilting, the small circles of the normal and reverse field polarities are intersected by each remanence small circle at four points. This gives four possible direct reconstructions (tilting/rotation  $< 180^\circ$ ), two of which belong to the normal and two to reverse field polarity.**

Altogether, this gives four possibilities for tilting and block rotation  $< 180^\circ$ , further on called *direct reconstructions*. The trends  $t'$  of the tilt axes of the two reconstructed tilting directions at a given distance  $d$  are:

$$t_1' = \arccos(+d / \cos I_{acq}) + D_{acq} \quad (2a)$$

$$t_2' = \arccos(-d / \cos I_{acq}) + D_{acq} \quad (2b)$$

Addition of equations (2a) and (2b) shows that the trends of the two tilt axes are complementary to  $180^\circ + 2D_{acq}$ :

$$t_2' = 180^\circ - t_1' + 2D_{acq} \quad (3)$$

$t_1'$  trend of the first reconstructed tilt axis;

$t_2'$  trend of the complementary second reconstructed tilt axis;

$d$  distance of a remanence small circle to its corresponding tilting direction or II-circle ;

$D_{acq}, I_{acq}$  normal reference field with positive inclination

Each of the two reconstructed tilt axes is rotated to match the present tilt axis either in one sense, e.g. implying normal polarity, or in the opposite sense, implying reverse polarity. The block rotations ( $br$ ) of one reconstructed tilt axis for normal polarity and reverse polarity reconstruction are inverse complementary to  $\pm 180^\circ$ :

$$br_n - br_r = \pm 180^\circ \quad (4)$$

$br_n, br_r$  block rotation from normal and reverse polarity reconstruction

If block rotation up to  $360^\circ$  is allowed, the possible direct reconstructions sum up to eight. Reconstructions have to be assessed according to their probability, mainly by considering the angles of backtilting and block rotation. Geological information such as upright or overturned bedding and a comparison to magnetic data

from nearby sites in most cases resolve ambiguity. If reconstruction is done using Fisher site means, the angle of backtilting for each solution can be determined. This allows the reconstruction of the bedding at the time of remanence acquisition.

The following examples (Fig. 1.9 and Fig. 1.10) illustrate the procedure of reconstruction and assessment. The remanence components of the sites are supposed to have a Fisher distribution giving a site mean, for which the angles of backtilting can be calculated. Conventions on rotations are as previously defined in Fig. 1.1 (again shown in Fig. 1.9 and 1.10). Fig. 1.9a gives remanence components, site mean, tilting direction, remanence small circle and the small circle of constant field inclination for site 22. Fig. 1.9b-e represent the four direct reconstructions with the angles of backtilting and resulting angles of block rotation.

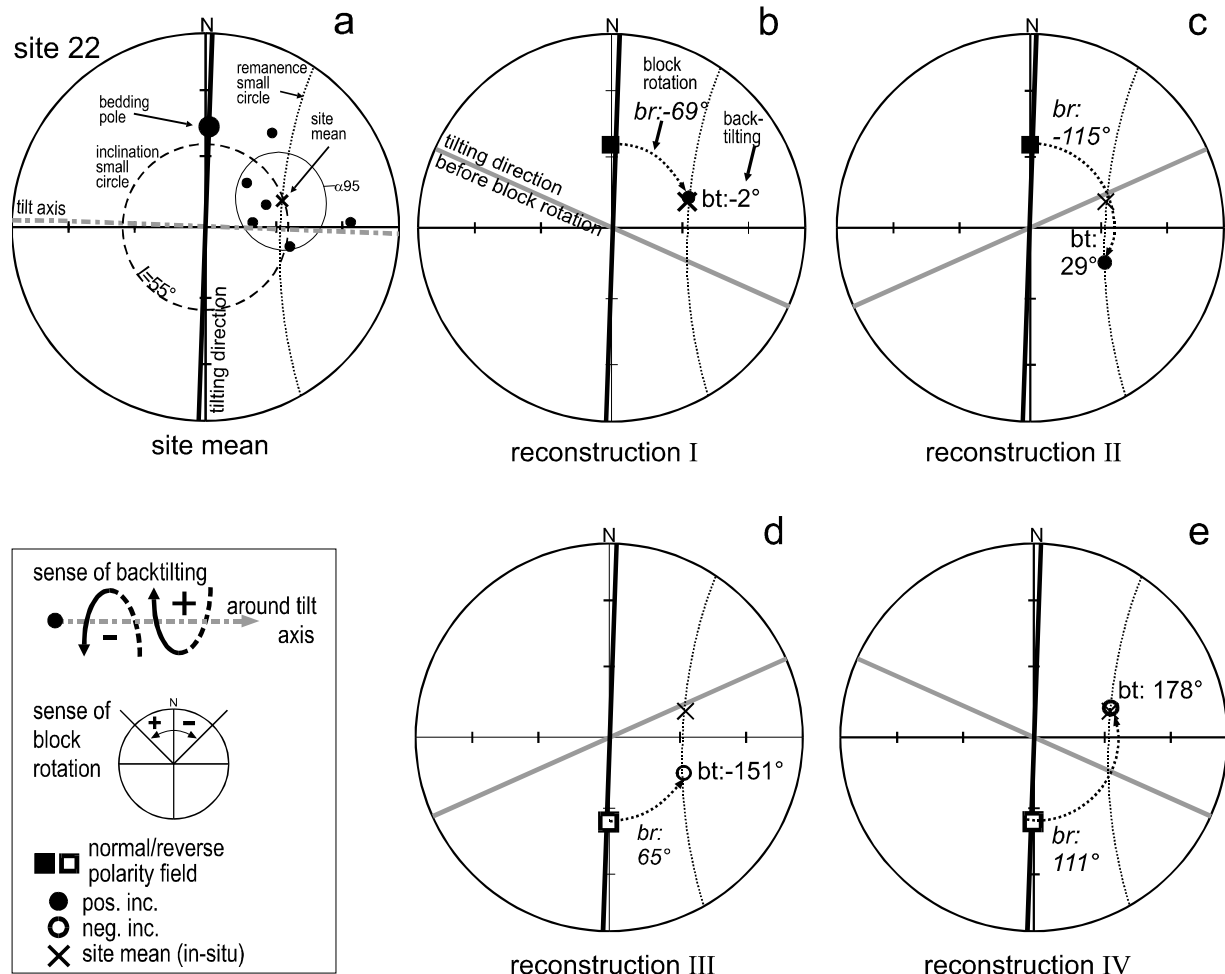
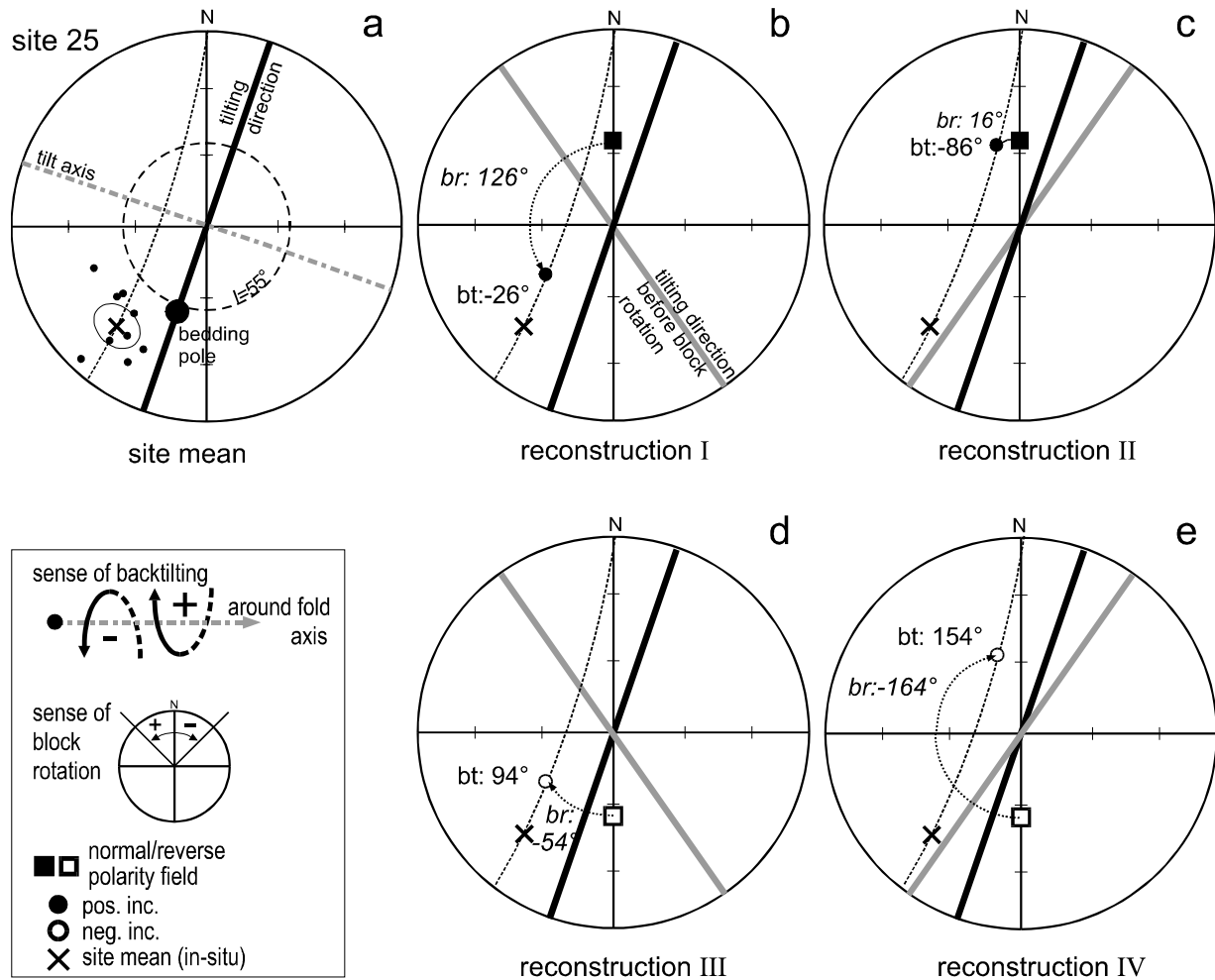

**Fig. 1.9: The four direct reconstructions for site 22. Acquisition field at  $D/I = 0^\circ/55^\circ$  and reverse. Angle of backtilting calculated for the site mean. Percent of untilting relates to present dip assumed to be upright. Reconstructed positions shown for site mean (open/full circles) and tilting direction (thick grey line). (a) Remanence components, site mean, tilting direction, remanence small circle and inclination small circle. Sense and angle of backtilting (bt) and resulting block rotation (br) as indicated in b-e. (b) Shortest path by  $-2^\circ$  (-4%) of backtilting giving a clockwise block rotation of  $-69^\circ$ . (c) Next possible reconstruction by  $29^\circ$  (67%) backtilting giving a  $-115^\circ$  clockwise block rotation. (d)  $-151^\circ$  (-351%) of backtilting giving a  $65^\circ$  counterclockwise block rotation. (e)  $178^\circ$  (415%) of backtilting giving a counterclockwise block rotation of  $111^\circ$ . The angles of backtilting of b and e, and c and d are inverse complementary to  $180^\circ$ .**

Reconstruction I (Fig. 1.9b) requires the smallest angle of backtilting and block rotation ( $2^\circ = -4\%$  untilting and  $-69^\circ$  block rotation). The small negative percentage of untilting is too small to be significant for overturned bedding. In this reconstruction, the remanence was acquired after tilting of the layer, and the magnetic record is constrained to the block rotation or to a part of it. This solution gives the shortest displacement and thus is the most probable reconstruction. Reconstruction II (Fig. 1.9c) gives  $29^\circ$  (67%) of

untilting and  $-115^\circ$  of block rotation. Bedding would be normal. Reconstructions III and IV (Fig. 1.9d and e) give tilting angles of  $-151^\circ$  ( $-351\%$ ) and  $178^\circ$  ( $415\%$ ). The present bedding dip of  $43^\circ$  does not allow the reconstruction positions to be reached within the range of untilting for an upright bedding dip of  $43^\circ$  and an overturned bedding dip of  $137^\circ$ . Hence, either tilting by more than  $180^\circ$  or tilting in two phases with opposite senses must be allowed to explain these solutions (see also Fig. 1.3d for this constellation).

Analogous to the angles of block rotation, the angles of untilting of reconstructions I and IV, and II and III are inverse complementary to  $180^\circ$  (see also equation 5), thus, it is sufficient to determine the tilting angles of the first two reconstructions and calculate the others through the symmetry.



**Fig. 1.10: The four direct reconstructions for site 25. For conventions see Fig. 1.9. (a) Site results and site mean. (b)  $-26^\circ$  ( $69\%$ ) of backtilting giving a counterclockwise block rotation of  $126^\circ$ . (c)  $-86^\circ$  ( $226\%$ ) of backtilting giving a  $16^\circ$  counterclockwise block rotation. (d)  $94^\circ$  ( $-248\%$ ) of backtilting giving a  $-54^\circ$  clockwise block rotation. (e)  $154^\circ$  ( $-404\%$ ) of backtilting giving a clockwise block rotation of  $-164^\circ$ .**

The reconstruction of site 25 is shown in Fig. 1.10. This example illustrates how different reconstructions can achieve similar probability when displacements become high. Reconstruction I (Fig. 1.10b) requires  $-26^\circ$  ( $69\%$ ) of backtilting giving a  $126^\circ$  counterclockwise block rotation and upright bedding. Reconstruction II (Fig. 1.10c) requires  $-86^\circ$  ( $226\%$ ) of backtilting giving a  $16^\circ$  block rotation. The tilting sense with its positive percentage implies upright bedding, but backtilting significantly exceeds the dip of  $38^\circ$ . This reconstruction could only be explained by a tilt of more than  $180^\circ$ , or a tilt first to a southward dip direction may have occurred and then, after remanence acquisition, back northward to the present dip direction. Reconstruction III (Fig. 1.10c) implies overturned bedding: Backtilting of  $94^\circ$  ( $-248\%$ ) is below the overturned tilt angle of  $142^\circ$ . This constitutes the most moderate solution in terms of rotation and backtilting

angles. Reconstruction IV (Fig. 1.10e) requires  $154^\circ$  backtilting (-40%) which does not significantly exceed the overturned tilt angle of  $142^\circ$ .

Reconstruction III would be chosen as the most probable since it requires the smallest angles of displacement and no reversal of the tilting sense. However, site 25 is part of the unidirectionally folded sequence of Fig. 1.4, from which a mean counterclockwise rotation of about  $20^\circ$  has been obtained. Thus, reconstruction II (Fig. 1.10c) is likely to be the correct solution. Either the site has been tilted by more than  $180^\circ$ , or two phases of tilting below  $180^\circ$  with opposite senses must have occurred.

## **1.6 Subsequent Tilt, Two Folding Phases and Simultaneous Displacement**

In the following, possible complications will be discussed. The first two usually can be identified from the analysis of the bedding within a folded sequence.

### **1.6.1 Subsequent Overall Tilting**

Any subsequent tilt of a whole folded sequence affects both bedding data and palaeomagnetic data. However, it will not affect the angular distance between in-situ remanence and  $\Pi$ -circle. If known to have occurred, both bedding data and remanence directions need to be tilted back until the  $\Pi$ -circle reaches its orientation prior to the overall tilt.

### **1.6.2 Second Phase of Tilting**

A second folding phase with tilting perpendicular to the first phase rotates a remanence direction away from an initial small circle on a further small circle perpendicular to the first one. This affects also the distribution of the bedding poles. The broader distribution will show up in both data sets and can be identified. If symmetrical, the small-circle distribution of the remanences becomes broader, but the mean small circle remains the same. Definition of this small circle can still be done, but is possible only if secondary tilting is not too intense and if representative sampling is done across the sequence. This should be true also for a second folding phase at an angle  $\neq 90^\circ$  to the first.

### **1.6.3 Simultaneous Tilting and Block Rotation**

Basically, the small-circle reconstruction does not indicate if block rotation occurred before or after tilting. In principle, there are three possibilities:

1. Block rotation after tilting, thought to be the general case.
2. Block rotation before tilting, implying a primary character of such an in-situ remanence.
3. Simultaneous block rotation and tilting.

Generally, changing the temporal sequence of rotations also will change the final result, because rotations are not commutative. However, there is an exception, thought to be represented by the process of tectonic folding (Fig. 1.11): The tilt axis rotates with the block rotation. Both axes are perpendicular to each other. The axis of the block rotation is not affected by tilting. If tilting and block rotation are exchanged, the final result will be the same (Fig. 1.11a).

Moreover, if these steps are exchangeable, they can be subdivided into incremental steps, combined alternatively and still will give the same final result. Eventually, subdivided into infinitesimals and arranged

alternatively, a simultaneous process of tilting and block rotation is obtained. The final result is always the same, but the path is different (Fig. 1.11b).

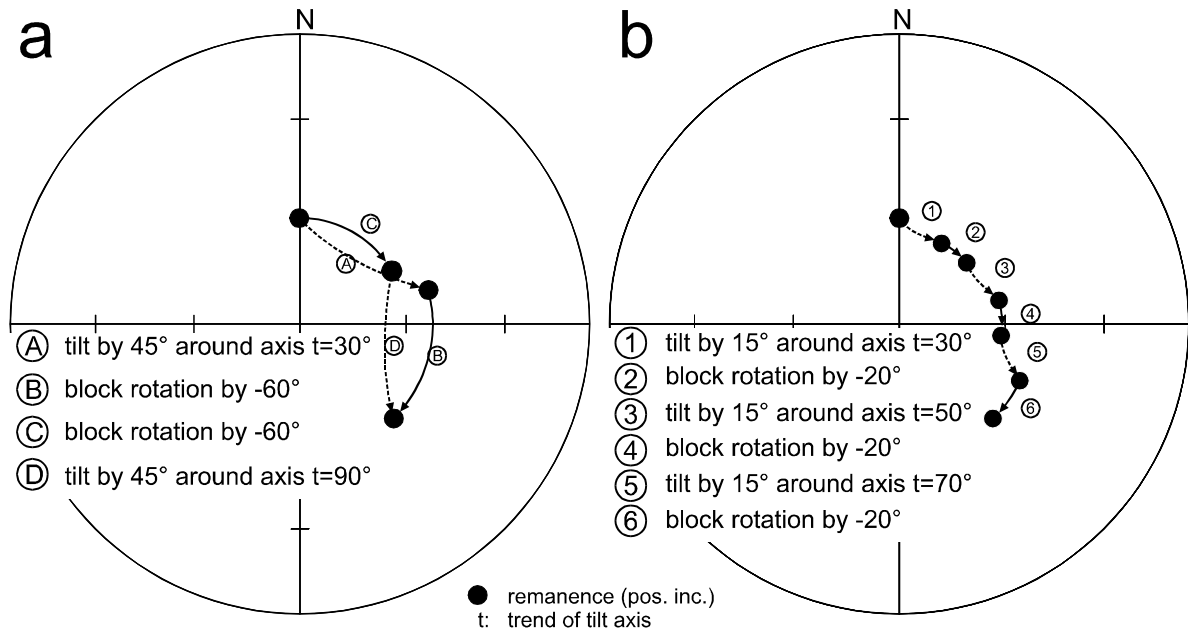

**Fig. 1.11: Exchanging and subdividing tilting and block rotation. Block rotation rotates the tilt axis, but tilting does not affect the axis of the block rotation. In this case, block rotation and tilting can be exchanged and still will give the same result (a). Subdivision into increments still yields the same final result (b). The displacement path is always different.**

Hence, also in the case of simultaneous or alternating block rotation and tilting, the small-circle reconstruction gives the correct angles of net tilt and net block rotation. This simultaneous process is likely to perform during folding (Fig. 1.12). Strata which are not parallel to the fold axis, must undergo block rotation during tilting in order to reach a tighter arrangement of the layers.

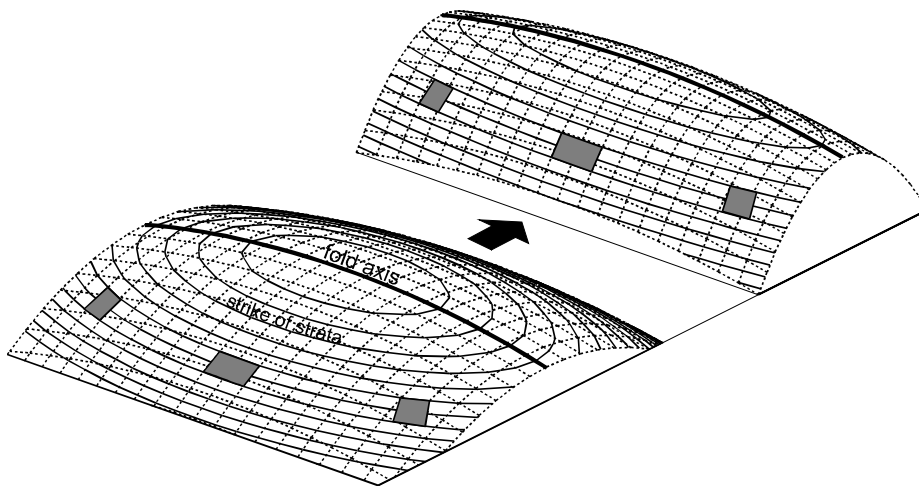

**Fig. 1.12: Schematic view of a fold with hinge culmination. Shaded rectangles shall represent internally rigid layer elements. During folding, layer elements which are not parallel to the fold axis, must undergo block rotation in order to reach a tighter arrangement of the layers. Tilting and block rotation will occur simultaneously.**

Fig. 1.13 shows remanence components of two sites that might have recorded simultaneous tilting and block rotation. The sites are taken from a fold and are some 50 m apart. Distributions seem to be on small circles, but not parallel to the corresponding tilting direction. If each remanence direction is tilted back, different amounts of block rotation are obtained. With the exception of one specimen in site 12 and two in site 14, the angle of backtilting seems to correlate with the obtained block rotation. The remanences that recorded the largest tilting, also exhibit the largest block rotation. However, secular variation is contained in these distributions. To proof the relation between block rotation and tilting, more remanence components

are necessary. Nevertheless, from the further results (see section 3.1), it is plausible that block rotation went along with folding in this area. Therefore, the remanence components shown in Fig. 1.13 could reflect this simultaneous displacement.

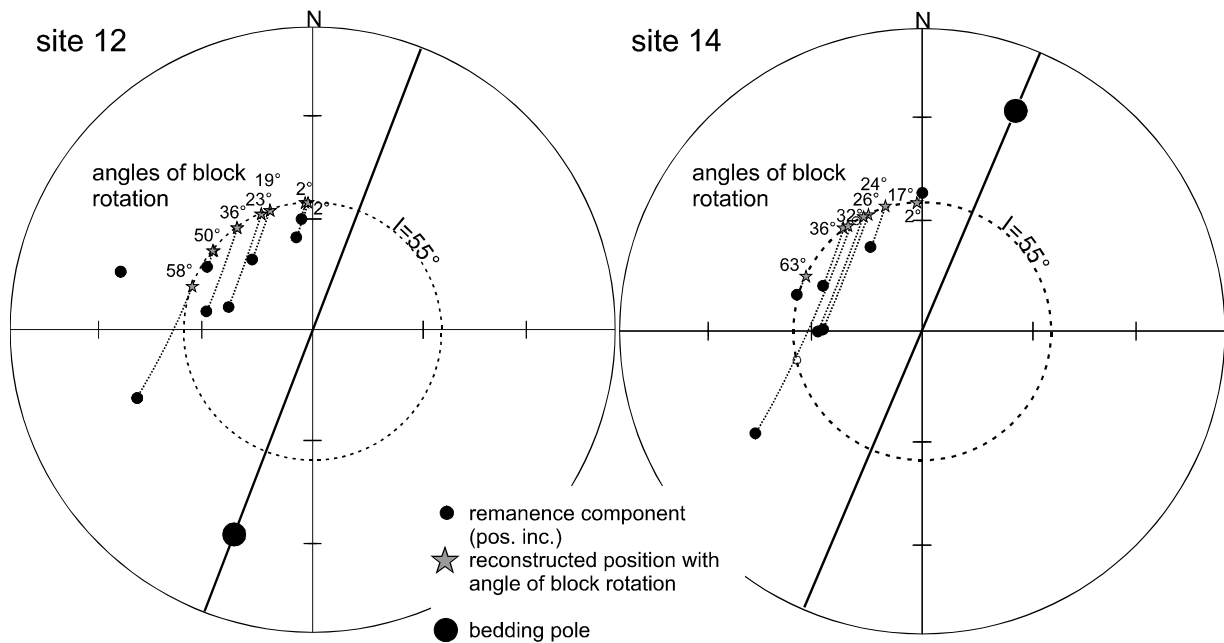

**Fig. 1.13: Remanence components from sites 12 and 14, both in red beds from the opposite limbs of one fold. Distributions seem to be on a small circle which is not parallel to the tilting direction. Each component has been backtilted to intersect a small circle of  $I_{acq} = 55^\circ$  giving a block rotation as indicated. One remanence component of site 12 is outside the possible range. The angle of backtilting correlates roughly with the angle of block rotation. Thus, tilting and block rotation may have occurred simultaneously.**

### 1.7 Finding a Mean Small Circle

If remanence components of a site are considered that show a Fisher distribution, the site mean can be taken for the calculation of the  $\alpha$ -angle and the small-circle reconstruction. As usual, the  $\alpha 95$  divided by  $\cos I_{acq}$  is taken as the confidence interval for the block rotation.

In order to reconstruct a given small-circle distribution parallel to its corresponding tilting direction or  $\Pi$ -circle, a mean small circle has to be calculated first. The small-circle distribution of remanence components in a site is a one-dimensional Gaussian distribution parallel to the tilt axis. It is obtained by allowing the remanence directions to rotate around the tilt axis. In this way, a former two-dimensional Gaussian distribution is reduced to a one-dimensional one. (Fig. 1.14).



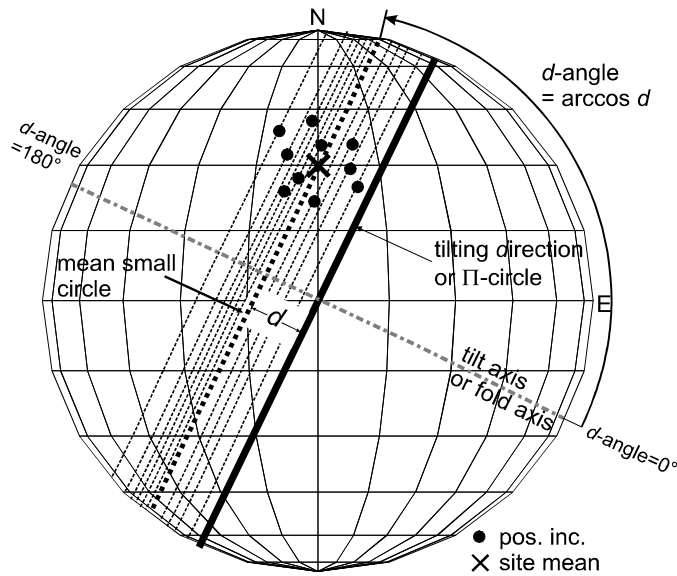

Fig. 1.14: Geometry of small-circle distributions. By allowing the remanences to rotate freely around the tilt axis, the two-dimensional Gaussian distribution is reduced by one dimension. Each remanence component can be seen to have its own small circle defined by the angular distance  $d$  or the  $d$ -angle  $\arccos d$ . Tilting direction (or  $\Pi$ -circle) and small circle intersect the tilt axis (or fold axis) at an angle of  $90^\circ$ . At a field inclination of  $I_{acq} = 0^\circ$   $d$  can vary between  $-1$  and  $+1$ , and the  $d$ -angle between  $180^\circ$  and  $0^\circ$ .

Each remanence component can be seen to have its own small circle defined by the angular distance  $d$  or the  $d$ -angle  $\arccos d$ . Tilting direction and small circle intersect the tilt axis at an angle of  $90^\circ$ . The angular distance  $d$  is a fraction of the radius, which equals the cosine of the so called  $d$ -angle (Fig. 1.14). At a field inclination of  $I_{acq} = 0^\circ$ ,  $d$  can vary between  $-1$  and  $+1$ , and the  $d$ -angle between  $180^\circ$  and  $0^\circ$ . The distance  $d$  of each remanence is:

$$d = \cos(D - t) \cos I \quad (5)$$

$d$  angular distance as a fraction of the radius ( $=1$ ),  $D/I$  declination and inclination of the in-situ remanence,  $t$  trend of the present tilt axis ( $0^\circ \leq t \leq 180^\circ$ )

The  $d$ -angle of a mean small circle is found by calculating the arithmetic mean of the  $d$ -angles  $\arccos d_n$  of  $n$  remanences:

$$\arccos d_{mean} = \frac{1}{n} \sum_n \arccos d_n \quad (6)$$

The 95%-confidence interval can be calculated using the usual approximation:

$$\alpha_{95} \approx \pm 1,96 \frac{S_d}{\sqrt{n}} \quad S_d \text{ standard deviation of } d\text{-angle} \quad (7)$$

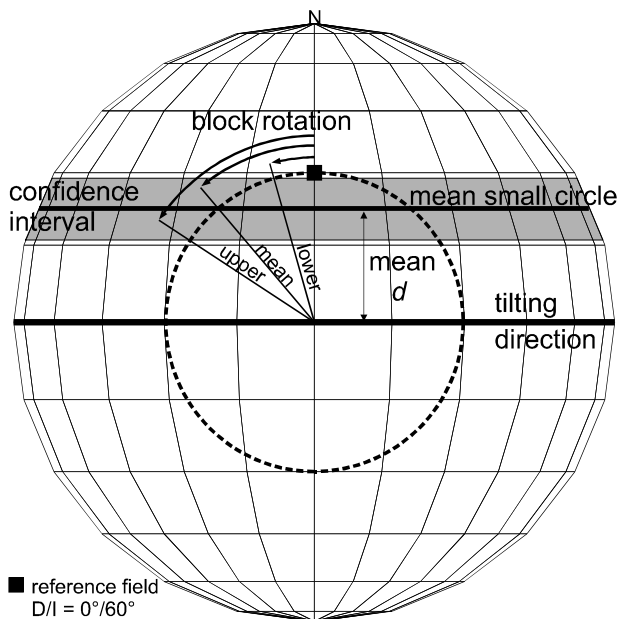

For the azimuth of the reconstructed tilt axis and the resulting block rotation, the confidence interval is asymmetric, except for a zero angular distance (Fig. 1.15). If one of the interval limits of the  $d$ -angle is below the maximum  $I_{acq}$ , the corresponding confidence limit for the reconstructed tilt axis cannot be calculated.

Fig. 1.15: The confidence interval for the mean  $d$ -angle is symmetric, but results in an asymmetric confidence interval for the azimuth of the reconstructed tilt axis and the block rotation. Asymmetry is zero at  $d=0$  and increases with the mean angular distance.

## 1.8 Estimation of the Field Inclination from In-Situ Remanences

Secondary palaeoremanences have been acquired at an unknown stage of tilting and cannot be restored to their original orientation without knowing the acquisition field. Therefore, the determination of the palaeofield inclination does not seem possible from an in-situ remanence. However, the angular distance of a remanence puts an upper limit on the field inclination (maximum  $I_{acq} = \arccos |d|$ ,  $|d|$  amount of  $d$ ). In the

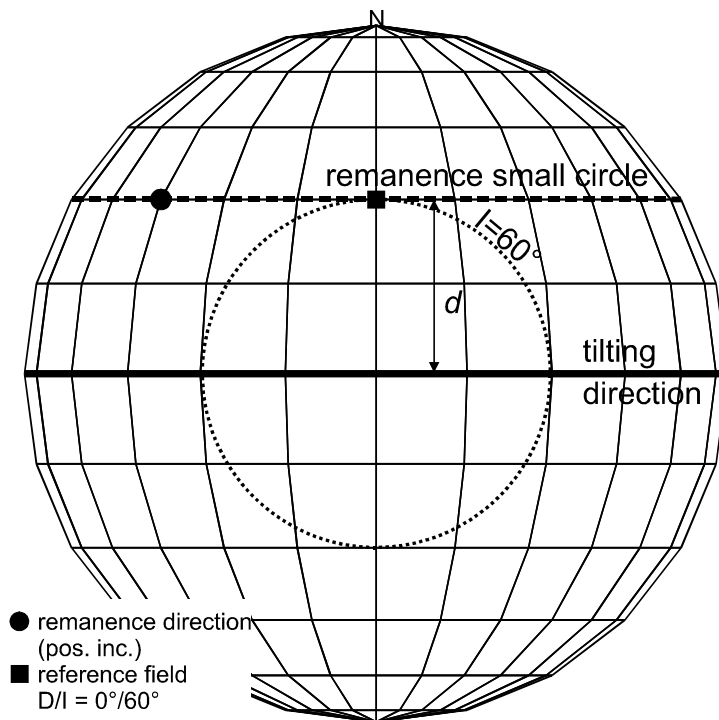

case of an originally E-W tilted site, this upper limit is the inclination of the acquisition field (Fig. 1.16): The inclination of the acquisition field is  $\arccos |d|$ . Since it is never known if a site has been block-rotated, always an upper constraint will be obtained.

**Fig. 1.16.** In the case of an E-W tilted remanence, the  $d$ -angle ( $\arccos d$ ) is the inclination of the acquisition field. If not E-W tilted, an upper constraint on the field inclination (maximum  $I_{acq}$ ) is given. As block rotation could have changed the original tilting direction, the angular distance is always an upper constraint.

Consequently, within a number of remanences, tilted in various directions between N-S and E-W, the inclination of the acquisition field will be found in the angular distance of the E-W tilted sites. If no originally E-W tilted sites are represented, an upper constraint on the field inclination will be found.

Fig. 1.17a depicts theoretical curves for the cumulative distribution of the maximum  $I_{acq}$  for a number of in-situ remanences, that have been tilted in directions uniformly distributed between E-W and N-S. The uniform distribution of the tilting directions makes the cumulative curve a straight line for each  $I_{acq}$ . Fig. 1.17b presents the cumulative distribution of the maximum  $I_{acq}$  of 43 sites from the southern Pamirs. The curve exhibits a significant increase in the cumulative number of sites above a maximum  $I_{acq}$  of  $55^\circ$ . The cumulative curve above  $55^\circ$  resembles a straight line indicating a rather uniform distribution of the reconstructed tilting directions. Hence, these  $55^\circ$  can be taken as the upper constraint on the field inclination at the time of remanence acquisition. Three sites have an  $I_{acq}$  below  $55^\circ$ . Reasons can be:

- Acquisition at a lower field inclination, possibly indicating a primary character.
- Displacement around inclined axes.
- Rockmagnetic and other reasons such as inclination shallowing, not averaged secular variation, and statistical and physical errors.

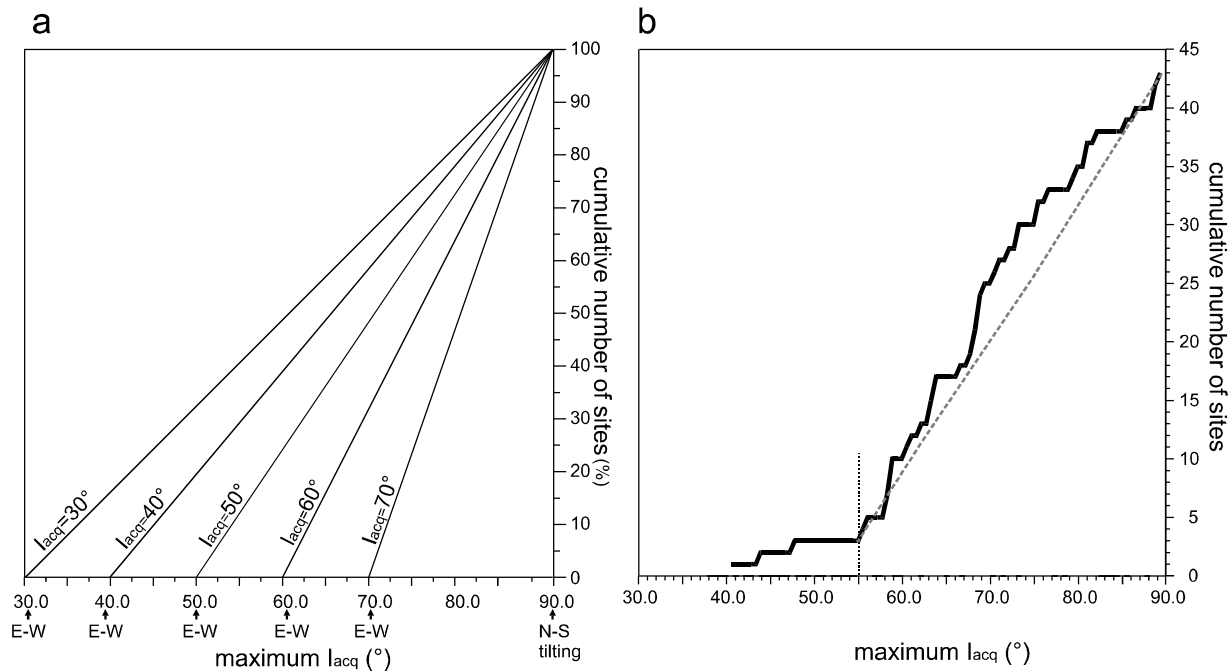

**Fig. 1.17: Constraints on the palaeofield inclination from tilted in-situ remanences.** Each angular distance of a remanence implies a maximum  $I_{acq}$ . The field inclination at the time of remanence acquisition is obtained from originally E-W tilted sites. (a) Theoretical curves for the cumulative distribution of the maximum  $I_{acq}$  of 100 in-situ remanences acquired at an inclination as indicated and tilted in directions that are uniformly distributed between N-S and E-W. The cumulative distribution curves are lines. (b) Example of the 43 sites from the southern Pamirs. The marked increase in the cumulative number of sites above 55° indicates that the field inclination unlikely exceeded this value. The curve resembles a line indicating a rather uniform distribution of the reconstructed tilting directions.

In practice, a site does not have to be exactly E-W tilted to give a reasonable constraint on the field inclination. The angular distance  $d$  is a cosine function of the azimuth of the tilt axis (equation (1) in section 1.3). Changing the azimuth from 0° to 10° reduces the maximum  $I_{acq}$  only to 1,01 of the original value, an azimuth of 20° still gives 1,06.

### 1.9 Further Aspects

The concept, that in-situ remanences effectively represent a magnetic record of net tectonic displacement, that can be reconstructed, adds new possibilities to palaeomagnetic and tectonic investigations, such as:

- Palaeomagnetic investigations can be extended to metamorphic sequences (e.g. using schistosity instead of bedding).
- Investigation of the increments and kinematics of folding and block rotation.
- Direct correlation of palaeomagnetic data to structural data from the same outcrop, e.g. brittle deformation data, cleavage, schistosity. Temporal sequences of folding and block rotation, formation of cleavage, brittle deformation, etc. can be resolved.
- Rock- and palaeomagnetic studies related to the processes of remanence acquisition and overprinting during metamorphism and deformation.

Besides this, sampling in the field must already account for originally supposedly E-W tilted sites to get the palaeoinclination. Field information on upright and overturned bedding is important.

### 1.10 A Modified Way of Data Processing

In the conventional procedure the interpretation depends greatly upon the primary character of the remanence which is assessed by fold tests. However, these tests can be misleading. Secondary remanences can be interpreted only if acquired completely after folding. With the techniques outlined so far, palaeomagnetic data processing can be rearranged. The conventional procedure is not replaced, but integrated (Fig. 1.18).

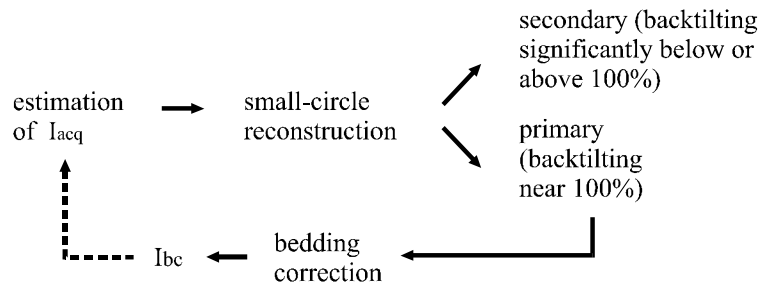

**Fig. 1.18. Modified way of data processing. For discussion see text.**

The small-circle reconstruction bases on the estimation of the palaeoinclination ( $I_{acq}$ ) which is assessed from the in-situ remanences. This has to be ensured by appropriate sampling. In contrast to the conventional procedure, a primary character is not a prerequisite for the interpretation. The information on the character of the remanence comes out as a final result and can be checked by fold tests. A remanence is primary, if the percentage of backtilting is around 100%. In this case, the inclination in bedding coordinates can be taken to optimise the small-circle reconstruction. Ideally, the palaeoinclination and block rotation derived from the small-circle reconstruction coincide with the values given by the bedding corrected site mean. Such a remanence is undoubtedly primary, and tilting and block rotation have performed around a horizontal and a vertical axis. Hence, the initial assumptions for the small-circle reconstruction can be checked in turn. Finally, when  $I_{acq}$  is known, the character of the remanence can be determined separately for each remanence direction, hence, a fold test is not absolutely necessary.