



**LEAD GRADUATE SCHOOL &
RESEARCH NETWORK**

2012-2016



**LEAD GRADUATE SCHOOL &
RESEARCH NETWORK**

2012-2016



Having been successful with its grant application within the Excellence Initiative of the German Federal and State Governments, the LEAD Graduate School (Learning, Educational Achievement, and Life Course Development) was founded at the end of 2012. Originally there were slightly more than 40 members. Since then, we have seen a rapid growth. Within four years, an interdisciplinary and international network of now more than 130 scientists from over 10 disciplines has been built up, postdoctoral training has been integrated into the program, and several new collaborations and research projects have originated out of LEAD. The growth and development are also reflected in the slightly updated official name: LEAD Graduate School & Research Network.

In the LEAD grant proposal, we formulated eight aims that can also be used to gauge the success of the program:

- Conducting cutting-edge research in fields of high relevance for evidence-oriented education
- Instigating successful interdisciplinary research in critical areas
- Promoting top-quality work in educational research in Tübingen and more generally
- Further increasing international visibility and impact
- Sustainability: creation of lasting structures for high-level research and training at Tübingen University
- Increasing the number of highly-qualified researchers and professionals in the field of evidence-oriented education at all levels
- Maintaining and increasing collaborative partnerships with research institutes such as the *Leibniz-Institut für Wissensmedien*
- Maximizing translational potential

In the current report, we describe in some detail the progress that has already been made in reaching these goals. As will become evident from the report, LEAD has been very successful in instigating cutting-edge research and successful interdisciplinary endeavors on relevant topics in educational research in Tübingen. Furthermore, there are now professional structures for research and training at Tübingen University, including the LEADing Research Center as a core facility, and collaboration with the two Leibniz Institutes has been established. At the same time, there is still room for improvement in terms of sustainable structures for translational potential. The need for highly-qualified researchers and professionals in the field of evidence-oriented education seems to have increased over the years. Moreover, in 2016, the federal and state governments decided to discontinue funding the Excellence Initiative graduate schools at the end of 2019. Hence, in addition to managing the rapid growth of LEAD-relevant research in Tübingen that we expect to see in the years to come, sustainability will be a major challenge for LEAD.

A handwritten signature in black ink that reads "Ulrich Trautwein". The signature is written in a cursive, slightly slanted style.

Ulrich Trautwein
LEAD Director

| | |
|---|----|
| ABOUT LEAD | 5 |
| What is LEAD? | 6 |
| The LEADing Research Center: Core Research Facility of LEAD | 11 |
| Training Program | 15 |
| SELECTED RESEARCH PROJECTS | 19 |
| Research Program | 20 |
| THE LEAD STARTING POINT: EDUCATION SCIENCES | 23 |
| Effects of Educational Policy Reforms in Upper Secondary School | 24 |
| Teaching Quality and Teachers' Professional Competence | 26 |
| Enrichment Courses for Gifted Primary School Children | 28 |
| INTERSECTION 1: LEARNING PROCESSES AND OUTCOMES | 31 |
| eChemBook: A Digital Textbook for Chemistry Education | 33 |
| Parents' Influence on Students' STEM Career Paths | 34 |
| Promoting Motivation for Mathematics | 36 |
| INTERSECTION 2: EDUCATIONAL NEUROSCIENCE | 39 |
| Workload-Adaptive Learning Environments for Math | 40 |
| Neurocognitive Underpinnings of Mathematical Learning | 42 |
| Neurofeedback Training for Children with ADHD | 44 |
| INTERSECTION 3: CLINICAL AND PERSONALITY PSYCHOLOGY AND EDUCATION SCIENCES | 47 |
| Social Cues in Classroom Settings | 48 |
| Students' Emotional Well-Being | 50 |
| Promoting Self-Regulation in Children | 52 |

| | |
|---|-----|
| INTERSECTION 4: LANGUAGE AND LEARNING | 55 |
| Linguistic Complexity of Schoolbook Texts | 56 |
| How Can Foreign Grammar Learning Be Facilitated? | 58 |
| Development and Training of Scientific Presentation Skills | 60 |
| INTERSECTION 5: EDUCATION, LIFE COURSE DEVELOPMENT, AND SOCIAL DISPARITIES | 63 |
| Environments and Educational Success | 64 |
| Pathways into, Through and out of Higher Education | 66 |
| Educational Transitions and Economic Outcomes | 68 |
| RESEARCH – RELEVANCE – RESPONSIBILITY | 71 |
| LEAD’s Impact on Society | 72 |
| Data Responsibility | 76 |
| EVENTS AND COOPERATIONS | 79 |
| Events | 80 |
| External Partners | 84 |
| Lab Visits of LEAD PhD Candidates | 87 |
| FACTS AND FIGURES | 89 |
| Graduates of the LEAD Graduate School & Research Network | 90 |
| Awards of LEAD PhD Candidates | 92 |
| Budgeting | 93 |
| Intramural Projects | 94 |
| Third-Party Funding | 96 |
| Memberships in Boards and Committees | 98 |
| Publications of LEAD PhD Candidates | 100 |

Psychology and Education Sciences | Social
onal Well-Being | Promoting Self-Regulation
arning | Linguistic Complexity of Schoolbook
Be Facilitated? | Development and Training
5: Education, Life Course Development, and
tional Success | Pathways into, Through and
itions and Economic Outcomes | Research –
on Society | Data Responsibility | Events and
Lab Visits of LEAD PhD Candidates | Facts
ate School & Research Network | Awards of
ral Projects | Third-Party Funding | Member-
ons of LEAD PhD Candidates | **ABOUT LEAD**
nter: Core Research Facility of LEAD | Train-
Research Program | The LEAD Starting Point:
Policy Reforms in Upper Secondary School |
l Competence | Enrichment Courses for Gift-
Learning Processes and Outcomes | eChem-
ucation | Promoting Motivation for Mathe-
EM Career Paths | Intersection 2: Educational
g Environments for Math | Neurocognitive
Neurofeedback Training for Children with

WHAT IS LEAD?

Founded in November 2012

Integrated research and training program on Learning, Educational Achievement, and Life Course Development (LEAD)

1 of only 45 graduate schools in Germany that are funded by the “Excellence Initiative” of the German federal and state governments



The LEAD members at the retreat in April 2015.

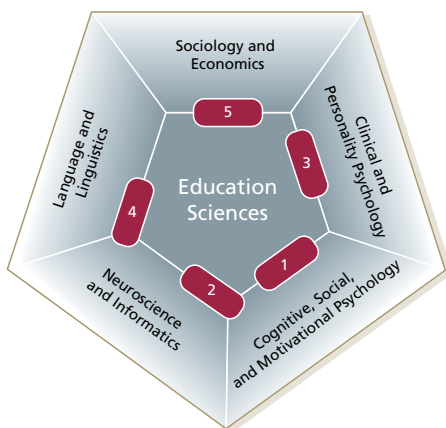

Figure 1. LEAD research fields and the five LEAD intersections.

The need to provide high quality education for all citizens, raising competence levels across the board, has become a pressing issue in most modern information and knowledge societies. Despite a broad willingness to implement an evidence-oriented approach to educational policy in many countries, the process is severely impeded by a shortage of empirical data on “what works” in education and by a shortage of qualified experts who help implement such an evidence-oriented approach in educational policies and practices. Furthermore, most pressing research questions in educational research are highly complex. To answer them, an appropriate research environment is necessary.

KEY QUESTIONS

The mission of the Tübingen LEAD Graduate School & Research Network is to provide optimal conditions for research and training that allow seven key questions to be addressed and answered: (1) What factors are associated with high and low achievement, and how can achieve-

ment levels in reading, mathematics, and science be improved, especially in high-risk groups? (2) How important are motivation and self-regulation for (academic) success in the short term and throughout life, and how can they be enhanced? (3) How can schools best deal with the increasing number of students with mental health problems? (4) How can teaching quality be improved? (5) What are the characteristics of the most effective learning environments and how can such environments be made available to all students? (6) How can the potential of modern media be fully exploited for learning? (7) What are the origins of social disparities in education and how can they be reduced?

INTERDISCIPLINARITY

Progress in evidence-oriented educational approaches depends on bringing together expertise and documented excellence from various disciplines, including education sciences, psychology, economics, sociology, informatics, psychiatry, and linguistics. It also involves new developments in research

methods and study designs. Hence, LEAD integrates several research fields as core disciplines of the research and training program. Five interface areas of high scientific priority are being investigated within an innovative interdisciplinary approach (see figure 1).

LEAD has also inspired a large number of new interdisciplinary collaborations and innovative projects which otherwise would never have been conceived: LEAD has brought together representatives of different disciplines, who, for the most part, did not have common projects before, for example computational linguists and educational scientists (see figures 2 and 3). Thus, interdisciplinary collaboration has become a crucial part of LEAD's research activities, e.g., intramural project funding is preferably given to projects involving more than one discipline, supervisory teams consist of faculty from two research fields (see figure 4), and doctoral candidates of different disciplines share offices and ideas on a daily basis in the LEAD headquarters.

INTERNATIONALITY

LEAD values internationality both with regard to the content of its research and to the education of the doctoral candidates. Traditionally, education sciences have primarily had a national focus, which in all likelihood has historically been encouraged by the great disparities between educational systems of different countries. By contrast, LEAD has an international focus and regards the differences in educational systems primarily as opportunities for research. Young LEAD scientists benefit from the vast international network of scientists and from the open-minded atmosphere. They are encouraged to gain experience in various



Figure 2. Institutions involved in LEAD which have successfully applied for third-party funds together.

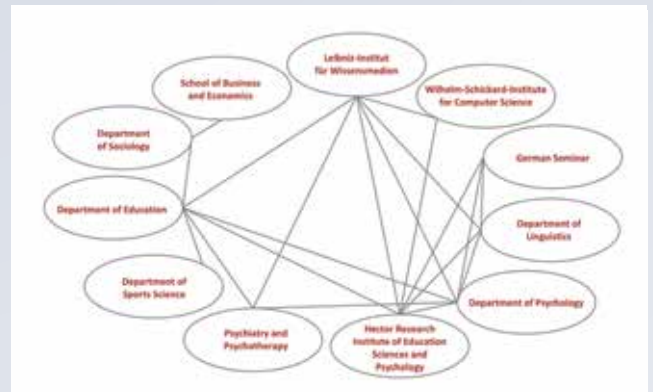

Figure 3. Institutions involved in LEAD which have published together.



Figure 4. Institutions involved in LEAD who jointly supervise doctoral candidates.



LEAD's student representatives in summer 2016.

thinking and working environments and are supported in doing so by numerous measures. For example, some doctoral candidates are co-mentored by Distinguished International Professors (see box below).

In a similar vein, the international affiliates, i.e., associated LEAD members from institutions abroad, strengthen certain research focuses (see page 84). International networking and career opportunities for PhD candidates are also supported financially through funds that are available for lab visits and conferences.

LEAD'S IMPACT

Since LEAD was founded four years ago, 17 doctoral candidates have submitted their thesis or already earned their PhD in the structured training program. An interdisciplinary research network on Learning, Educational Achievement, and Life Course Development has been established and has developed into a flourishing community. LEAD has had a lasting impact on the University of Tübingen as well. LEAD and

the third-party funding that LEAD helped to secure (e.g., the Hector Research Institute of Education Sciences and Psychology and the Postdoctoral Academy, see page 96) have contributed considerably to the national and international visibility.

As far as faculty is concerned, LEAD has contributed to a broadening of the university's key competencies in the field of education since the "LEAD fit" has played an important role in the selection of new professors. The faculty is highly productive, having published many papers in high-ranking international journals. LEAD is also well-represented at the most important conferences of its disciplines and is sought-after as an international partner.

These achievements have not gone unnoticed. Adequate public relations activities have made LEAD's work known to a broader audience; thus, the university has been able to establish itself as an expert on educational matters in the public eye. A list of LEAD's research achievements can be found in the chapter "Facts and Figures".

ORGANIZATION

The LEAD Graduate School & Research Network is built on lean management structures and flat hierarchies that ensure its efficient governance and successful collaboration among its members. Its individual bodies (red) and accompanying and evaluating bodies (grey) are shown in figure 5.



Figure 5. LEAD's organizational structure.

DISTINGUISHED INTERNATIONAL PROFESSORSHIPS

- Clancy Blair, New York University, USA
- Jacquelynne Eccles, University of California, Irvine, USA
- Kou Murayama, University of Reading, UK
- Patrick Rebuschat, Lancaster University, UK
- Brent Roberts, University of Illinois, Urbana-Champaign, USA
- Herman van de Werfhorst, University of Amsterdam, NL
- Tamara van Gog, Utrecht University, NL

The Distinguished International Professors work in Tübingen for several weeks each year. They co-mentor PhD candidates, work together with LEAD members on research projects, and host lab visits.

STEERING BOARD

Mareike Bierlich (Scientific Coordinator)
 Maria Chinkina (PhD Representative)
 Thomas Dresler (Representative of the Junior Research Group Leaders)
 Ann-Christine Ehlis (Gender & Diversity Representative)
 Peter Grathwohl (Representative of the President's Office)
 Peter Gerjets
 Friedrich W. Hesse
 Detmar Meurers
 Benjamin Nagengast (Vice Director)
 Katharina Scheiter
 Ulrich Trautwein (Director)

MANAGEMENT

Mareike Bierlich (Scientific Coordinator)
 Sophie Freitag (Assistant Scientific Coordinator)

GENDER & DIVERSITY BOARD

Ann-Christine Ehlis
 Summer Semester 2016: Anne-Kathrin Knauf
 Winter Semester 2015/16: Cansu Atlay, Justin Hudak
 Summer Semester 2015: Michèle Suhlmann
 Winter Semester 2014/15: Andreas Hartung
 Summer Semester 2014: Leona Hellwig
 Winter Semester 2013/14: Carina Walter

POSTDOC REPRESENTATIVES

Summer Semester 2016: Dominik Becker, Christiane Bertram
 Winter Semester 2015/16: Dominik Becker, Christiane Bertram
 Summer Semester 2015: Karin Berendes, Johann Jacoby
 Winter Semester 2014/15: Karin Berendes, Johann Jacoby
 Summer Semester 2014: Karin Berendes, Johann Jacoby

PhD REPRESENTATIVES

Summer Semester 2016: Cansu Atlay, Maria Chinkina, Ulrich Ludewig
 Winter Semester 2015/16: Thomas Lösch, Katharina Braungart, Maria Chinkina
 Summer Semester 2015: Juliane Kant, Thomas Lösch, Petra Bugl
 Winter Semester 2014/15: Juliane Kant, Petra Bugl, Michael Grosz
 Summer Semester 2014: Juliane Kant, Hanna Gaspard, Sowmya Vajjala
 Winter Semester 2013/14: Juliane Kant

LEADING RESEARCH CENTER

Ingrid Bildstein (Public Relations)
 Johann Jacoby (Study Design and Analyses)
 Stefanie Maas* (Schools & Research)
 Ulrike Michael (Schools & Research)
 Manuela Mild (Public Relations)
 Lisa Sitterle (Schools & Research, in collaboration with Tübingen School of Education)
 Christina Warren (Public Relations)

IT ADMINISTRATION

Michael Moser

ADVISORY BOARD

The advisory board consists of leading scientists in the core research fields of LEAD. As ‘critical friends’, they review the development of LEAD and advise the university and the steering committee on LEAD’s advancement and future plans.

Paul Kirschner (member since 2015, speaker of the advisory board) – Paul Kirschner is a professor of psychology and lifelong learning at the Netherlands Laboratory for Lifelong Learning (NeLLL) and the Department of Psychology at the Open University of the Netherlands as well as a professor of Educational Science at the Research Centre Learning in Interaction at Utrecht University. His areas of expertise include lifelong learning, information and communication technology in education, the development of learning materials for teacher extensive education and distance learning and text characteristics and learning processes.

Jürgen Baumert (member since 2015) – Jürgen Baumert is Director Emeritus of the Max Planck Institute for Human Development, Berlin, Professor of Education at the Humboldt University and the Free University of Berlin. His research and publications focus on learning and instruction, teacher expertise, large-scale international assessments (TIMSS and PISA), development of educational systems, and cognitive and motivational development in childhood and adolescence.

Jill Burstein (member since 2015) – Jill Burstein is the Director of Research for the Natural Language Processing Group in the Research Division at Educational Testing Service in Princeton, New Jersey. Her research interests span natural language



LEAD’s Advisory Board and Steering Board
(missing Nora Newcombe and Ann-Christine Ehlis) in February 2017.

processing for educational technology, automated essay scoring and evaluation, discourse and sentiment analysis, argumentation mining, education policy, English language learning, and writing research.

Diana Dolmans (member since 2016) – Diana Dolmans is a professor in the field of innovative learning arrangements at Maastricht University. Since 2016, she has also been the scientific director of the Interuniversity Centre for Educational Research (ICO) in the Netherlands. In her research, she investigates key success factors of innovative curricula within higher education, more specifically problem-based learning. Her studies focus on the role of tasks, the role of the teacher and the role of students within innovative curricula.

Nora Newcombe (member since 2016) – Nora Newcombe is the James H. Glackin Distinguished Faculty Fellow at Temple University in Philadelphia. Her major research fields include cognitive development, cognitive psychology and cognitive science, the development of spatial thinking and reasoning, and the development of episodic memory. She is also the principal investigator of the Spatial Intelligence and Learning Center, a national Science of Learning Center.

Eric Stice (member since 2016) – Eric Stice is a research professor at the University of Texas at Austin and a senior research scientist at Oregon Research Institute. His research has primarily focused on identifying risk factors that predict the onset of eating disorders and obesity, as well as the development and evaluation of prevention programs for these conditions.

THE LEADING RESEARCH CENTER: CORE RESEARCH FACILITY OF LEAD

The LEADing Research Center (LRC) is the core research facility of the LEAD Graduate School & Research Network. Supporting the LEAD mission of excellent, relevant, and responsible research in education since 2012, the LRC has established a framework of study support and consulting in the following three areas:

- (1) study design and analyses
- (2) schools & research
- (3) public relations

The LRC assists researchers in developing efficient study designs for intervention and evaluation studies as well as in the analysis and re-analysis of data, in securing access to the field for new studies, and in disseminating the research findings to different target groups in practice, policy, administration and public. Fulfilling its role as a core research facility at the interface between science and practice, the LRC services are available to all LEAD members, as well as in parts to members of the Hector

Research Institute of Education Sciences and Psychology and the Tübingen School of Education (TüSE).

The LRC currently has five staff members and one student assistant who support and facilitate cutting-edge research.

STUDY DESIGN AND ANALYSES

Research projects conducted at LEAD include large intervention and evaluation studies (specifically intersections 1, 3, 4 and, to a lesser extent, 2), the analysis of observational data (specifically, LEAD intersection 5), but also controlled laboratory studies (all intersections). Whereas each of these study types have specific advantages and features beneficial to the development and extension of evidence-inspired education, they also have critical requirements and pose specific challenges, for example regarding the sampling of participants, study design and analytical strategies. In order to ensure that the studies conducted at LEAD and their results can give optimally informative and reliable answers to the research questions, empirical studies are supported and accompanied by methodological consulting from the inception of the research idea on, throughout the design and planning phases as well as the concrete data collection and finally during the stages of statistical analysis, including integration, presentation and reporting of the results.

To this end, LEAD members confer with the method consultant of the LRC as necessary. They receive individual recommendations and help regarding the formulation of research questions or hypotheses and the optimal fit of the design of a study with them (both with data sets that have



At the "Science Day", hosted by the LRC, LEAD's researchers give workshops for teachers.

been collected previously as well as data to be collected subsequently), data collection logistics and techniques, statistical analysis, and further resources that they can recruit (e.g., literature, software, or other researchers within and around LEAD that have special expertise and experience pertinent to the present study). During the consultations, the sustainable acquisition and dissemination of skills and knowledge to doctoral candidates are emphasized. Also, special attention is given to the differentiation and subsequent integration of methodological approaches from the various (sub-)disciplines represented at LEAD in order to strengthen and develop intra- and interdisciplinary communication and collaboration.



LEAD director Ulrich Trautwein talking to headmasters at the "Science Day".

SCHOOLS & RESEARCH

With currently two part-time positions in the unit "Schools & Research", the LRC strives to secure access to schools while developing formats that outline scientific results of educational research for a practical educational interpretation.

The team is dedicated to guaranteeing smooth processes with respect to data collection at schools. It guides all members through the approval process of studies, through the ethics committee at the University of Tübingen and through the school authorities. It serves as an interface between researchers, schools and educational administration for all studies conducted in schools.

The LRC offers counselling on aspects such as data security and phrasing of study approval applications, or gives information on whom to contact for a certain request.

Researchers can thus profit from the experience and support of the LRC during the study approval process.

LEAD members planning data collection at schools are required to sign a quality agreement committing themselves to the standards of LEAD with regard to scientific studies (e.g., submit all materials to LRC for approval, provide suitable information for participants, give feedback on results to participants). The quality agreement is based on best practices. These are compiled, continually updated and improved by the staff of the LRC.

Schools participating in a LEAD study can thus rely on highest quality standards. The LRC offers support regarding communication with headmasters or teaching staff. Moreover, it coordinates study requests at schools and study timing during the

school year and ensures that researchers give feedback to schools and approving authorities after data collection.

Over the past four years, the LRC has significantly strengthened the contact to and exchange with teachers, schools and the educational administration. Established in 2013, the school partnership program "Schools & Research" (Schule & Wissenschaft) aims at strengthening the tie between schools and educational research. The expanding network of LEAD partner schools currently comprises 13 schools of different school types: Eleven of them are Gymnasien (academic-track high schools), one is a vocational school (Berufsschule), and one an elementary school (Grundschule).

Schools cooperating with LEAD agree on participating in scientific studies on a regular basis and in turn benefit from various

offers. Among these are scientific feedback on study results after data collection and school relevant talks or workshops by LEAD experts exclusively for the teaching staff at the respective school.

Since 2014, LEAD has hosted a “Science Day” (Tag der Wissenschaft) for LEAD partner schools and other interested schools as well as members of the educational administration. At this annual event, participants have the chance to gain insight into LEAD research during talks, workshops and personal exchange with LEAD researchers. Teachers and headmasters also have the opportunity to meet and exchange with other teaching professionals in the network.



LEAD.SCHULE – EDUCATIONAL SCIENTISTS BLOG

In September 2016, the LEADing Research Center set up a new channel of communication by launching the website and blog LEAD.schule. It aims to make educational research accessible to the general public, with a special focus on school principals, teachers and parents, and offer another opportunity for the exchange between science and school practice. How do you motivate students to learn mathematics? What makes a good teacher? LEAD scientists present research findings and their potential implications by blogging about their research in everyday language and discussing current educational topics.

In addition, LEAD.schule contains information about current studies conducted at schools, thereby providing an information platform for teachers and parents who look for more details on LEAD research and on the partnership program “Schools & Research” (see left page).

PUBLIC RELATIONS

With science communication becoming more and more important to provide a stronger understanding of current research in all parts of society and a reliable basis for decision-making, it was one of the goals of the foundation of LEAD to develop professional structures in public relations. Consequently, LEAD's PR team aims to promote the dissemination of scientific findings to educational policy, administration and practice as well as to the interested public by communicating them in a way that is suitable for the respective target group. However, LEAD does not view public relations as a "promotional campaign" for research results, but rather as a way of acknowledging its social responsibility. The general principle followed is the adequate "translation" of relevant research results

and establishing the "voice of science" as part of public discourse.

What started with establishing fundamental PR measures four years ago, now comprises a wide range of tools for communication and dissemination. In addition to regular press releases (see LEAD's Impact on Society, page 72), the LRC has developed several web pages to reach out to various audiences with tailored content (see previous page).

Further measures of the PR team at LEAD include lectures for the public, internal and external newsletters, short films, workshops on science communication and a wide range of different publications such as research brochures as well as study and event flyers.



Mass media covering LEAD's research.

TRAINING PROGRAM

The LEAD Graduate School & Research Network aims at fostering outstanding doctoral research on education-related issues and at maintaining the highest standards at all levels of academia, e.g., through providing cooperative research opportunities and supportive thesis supervision, professional career building, and smooth administrative services. LEAD focuses on quality over quantity. Therefore no more than 20 candidates per year are admitted in a competitive process.

PhD candidates within LEAD profit from a structured PhD training program featuring a broad variety of obligatory and non-obligatory individual training components. The program focuses on three areas of competence: content and methods of research and professional transdisciplinary skills. All doctoral candidates take classes that allow them to effectively pursue the mission of the LEAD Graduate School & Research Network.

Figure 6.
LEAD's structured training program.

LEAD postdocs can apply to become members of the Postdoctoral Academy at the Hector Research Institute of Education Sciences and Psychology and benefit from workshops, coaching, close mentoring and access to an international network of researchers to advance their academic careers.

OBLIGATORY COMPONENTS

Before each cohort of new PhD candidates start their work at LEAD, an orientation day that covers the topics and core values of LEAD is organized for them. This day serves to communicate implicit and explicit norms and to facilitate the candidates' reflection on ethics and the keys to successful research. The PhD candidates experience what LEAD is all about when they take part in the most important LEAD event: The LEAD retreat, which all LEAD members are asked to attend, is a three-day event that takes place off-site at the begin of every semester. The main features of the retreats are presentations by PhD candidates, poster fairs and keynote lectures by external experts. The central goal of the retreats is to allow the PhD candidates to receive valuable feedback on their research from their colleagues, faculty and external experts, and to facilitate interdisciplinary collaboration. The retreat is not only the most important event of the semester but also the one most eagerly anticipated. By now over 100 participants attend and the number is increasing every semester.

LEAD strives to create a research environment in which the PhD candidates get the support needed to enable them to complete their PhD within three years. In comparison to other graduate schools,

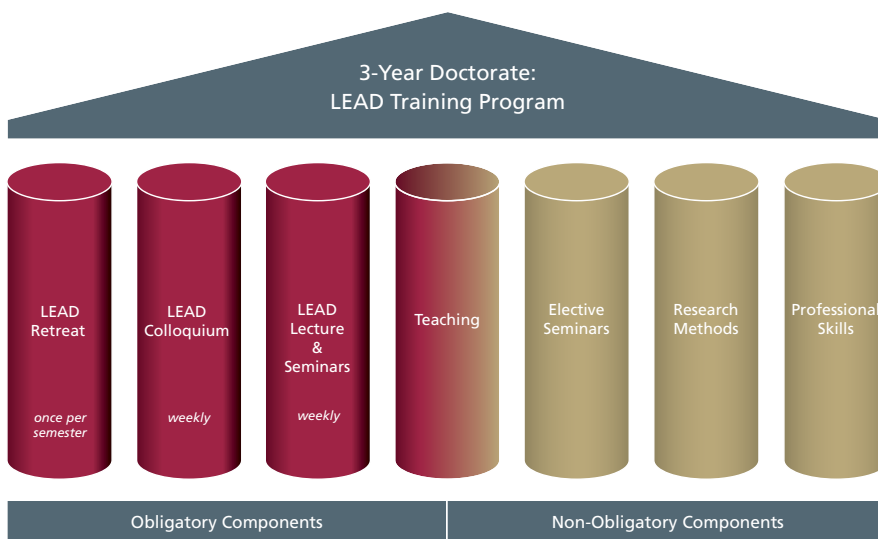

the core curriculum is less extensive. All doctoral candidates are required to attend only three courses: an introductory semester course giving an overview of education sciences principles, presented by education sciences faculty, one seminar from one of the LEAD research fields and one seminar on educational policy and practice. They also attend the weekly LEAD research colloquium, whose purpose is to strengthen interdisciplinary interaction. It aims at providing a venue for scientific discussion and talks by PhD candidates to practice, e.g., for upcoming conference presentations. The types of sessions alternate between PhD talks, journal clubs, and workshops. The last obligatory component of the structured

training program is the LEAD lecture series, which is held intermittently during the semester. LEAD faculty and PhD candidates invite national and international experts from every LEAD discipline to visit and hold a lecture. Doctoral candidates are encouraged to meet individually with these guests to discuss research and career questions. The lecture series is also part of LEAD's international strategy.

NON-OBLIGATORY COMPONENTS

The non-obligatory part of the training program is designed to equip doctoral candidates with skills that they can use in their dissertation work as well as in their future

careers. For example, they can take methods and methodology classes, which are held on-demand mostly by LEAD faculty. Workshops and seminars targeting candidates' professional skills include academic writing, German language classes, leadership skills and supervision for advanced graduate students and postdocs, project management, career planning and development. These classes are primarily offered by the Graduate Academy at the University of Tübingen. Advanced doctoral candidates' have the opportunity to gain knowledge and experience in teaching. They are included in the planning and organization of courses and assist in selecting course topics and designs.

SUPERVISION AND MENTORING

LEAD has implemented a structured program with mutual obligations between supervisors and doctoral candidates. It provides the necessary organizational support and evaluates the progress of doctoral dissertations. Each doctoral candidate has a team of at least two supervisors. We regard regular informal meetings with the supervisors as essential for the progress of the doctorate projects. In addition to these informal meetings, the candidates meet with their supervisors once a year to formally evaluate the progress of the doctorate project. LEAD PhD candidates are asked to submit reports to the LEAD steering board after 6 months (exposé) as well as 12 and 24 months (progress reports.) These reports are discussed and commented by the steering board members, and feedback is given to the doctoral candidates.

Near the end of the PhD work, approximately 9 months before the submission of the dissertation, candidates have a formal meeting with their supervisors to



TEACHING

Within the framework of the training program, advanced doctoral candidates and postdocs are invited to gain teaching experience in the university context, which is an important part of their preparation for their academic careers. The LEAD staff and faculty support them in acquiring the "Baden-Württemberg Teaching Certificate" and mentor them to ensure high quality in teaching.

Not only do the young researchers in LEAD profit from the possibility to teach, but also the students at the University of Tübingen. LEAD members pass on the interdisciplinary findings and spirit of LEAD to students and future generations. LEAD PhD candidates and postdocs are involved in many bachelor and master programs in all LEAD disciplines and in teacher training programs to impart basic knowledge in education sciences and research methods. Approximately 30 courses are offered every semester by LEAD PhD candidates and postdocs. They teach courses in programming for computational linguistics, courses on language promotion in early childhood, evaluation of social policies and intervention programs, education and life course research, intelligence diagnostics, machine learning and artificial neural networks in biomedical applications, personality development and current research trends as well as courses in education sciences, quantitative data analysis and research methods.

Hence, despite the focus on research, it's important to note that funding within the Excellence Initiative also improves learning and instruction for a large number of students at the University of Tübingen.

talk about possible career paths. Among other issues, career options within LEAD and other research labs are discussed, as well as the requirements for successful candidates.

PUBLICATION-BASED DISSERTATION

Consistent with the requirements of the various disciplines, a publication-based dissertation procedure has been established at the Tübingen Graduate Academy. In the LEAD Graduate School & Research Network, for most of the participating disciplines, a dissertation will typically comprise at least three (submitted or accepted) manuscripts with the candidate as first author, submitted to high-ranking international journals, as well as a summarizing introduction and a comprehensive discussion. The submission of further collaborative manuscripts is encouraged. In reasonable cases (e.g., specific traditions in some research areas), equivalent achievements (book, traditional dissertation) are accepted.

LEAD RESEARCH SUPPORT SYSTEM

INTRAMURAL RESEARCH FUNDS

- Support promising research projects with a high potential to answer LEAD key questions
- Total sum of 120.000 € per year
- Priority given to projects that are part of a dissertation and projects involving more than one discipline so as to act as an incentive for interdisciplinary research
- Provide grant proposal writing experience for the PhD candidates

PERSONAL BUDGETS

- 1.500 € per student for research expenses, travel and external classes
- 1.500 € per student for open access publications or proofreading services

CONFERENCE FUNDS

- Funding for national and international conferences or workshops

LAB VISITS

- Funding for travel to and accommodation during domestic or international lab visits
- For a length of weeks or months

BRIDGING FUNDS

- Support for candidates with outstanding dissertations
- Part-time postdoc positions for up to twelve months after completion of the dissertation

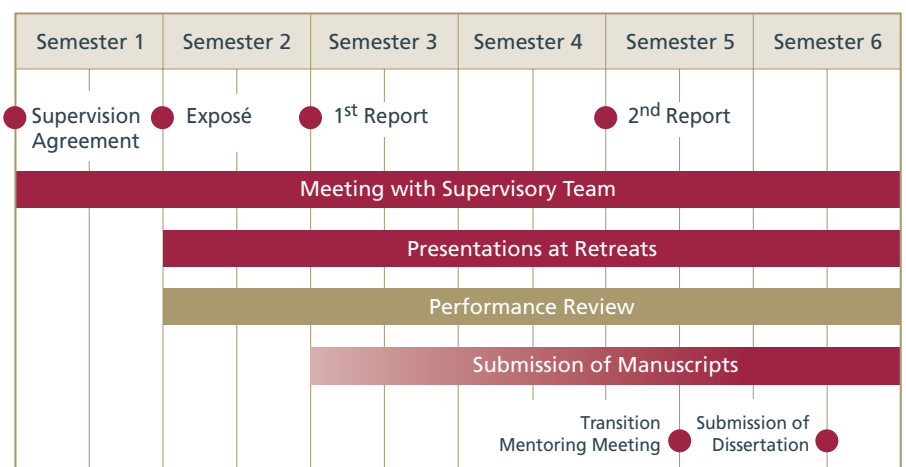

Figure 7. Supervision and mentoring at LEAD.

ility | LEAD's Impact on Society | Data Re-
ents | External Partners | Lab Visits of LEAD
duates of the LEAD Graduate School & Re-
ndidates | Budgeting | Intramural Projects
ards and Committees | Publications of LE
s LEAD? | The LEADing Research Center:
Program | **SELECTED RESEARCH PROJECTS**
Point: Education Sciences | Effects of Ed-
ary School | Teaching Quality and Teach-
nt Courses for Gifted Primary School Chil-
s and Outcomes | eChemBook: A Digital
ting Motivation for Mathematics | Parents'
 | Intersection 2: Educational Neuroscience
nts for Math | Neurocognitive Underpin-
edback Training for Children with ADHD |
hology and Education Sciences | Social Cues
al Well-Being | Promoting Self-Regulation
Learning | Linguistic Complexity of School-
earning Be Facilitated? | Development and
Intersection 5: Education, Life Course Devel-
ments and Educational Success | Pathways
Educational Transitions Economic and Out-

RESEARCH PROGRAM

In Germany and many other countries worldwide, large-scale student achievement studies such as the Third International Mathematics and Science Study (TIMSS) and the Program for International Student Assessment (PISA) have raised considerable concerns about the conditions, processes, and outcomes of institutionalized and non-institutionalized learning. The particular strengths of studies such as TIMSS and PISA lie in their reliable and valid assessment of competence levels across countries, which allow problems and challenges for research and educational policy to be identified. However, due to their emphasis on assessment rather than on the causes and consequences of learning, achievement, and life course development, additional studies are needed to answer many pressing questions which large-scale assessments such as TIMSS and PISA do not address. Most important, there is a clear need for empirically supported knowledge to answer critical “how to” questions.

LEAD aims at contributing to empirically supported knowledge by bringing together various research fields that work on education-related topics. Although their central research questions are closely related and interdisciplinary approaches are highly productive, these various research fields dealing with LEAD’s key questions had not been sufficiently integrated in empirical educational research in Tübingen and elsewhere for a long time. As a result, no mutual fertilization took place despite obvious overlaps in research agendas. However, it has become evident that the “big questions” in research on education are highly complex and cannot be satisfactorily examined within the confines of a single discipline. Instead, such questions need to be addressed within collaborative research programs spanning many years and bringing together researchers from various backgrounds.

For these reasons, LEAD considers interdisciplinary cooperation a key to progress in empirical educational research and combines a prolific education sciences program with the integration of several additional research fields. This interdisciplinary approach takes on different forms, ranging from loose cooperation to intensive collaboration. Yet this alone is no guarantee for a successful research program. Whether an interdisciplinary approach is successful or not depends on the questions studied, the disciplines involved, and the traditions of research and student training in a specific field and in a specific country. Thus, interdisciplinary work has to be tailored to the specific goals of the respective research and training endeavor.



In his research, LEAD PhD candidate Xiaobin Chen bridges the gap between computer technology and language education.

Our work integrates three principles of interdisciplinary research: (1) Interdis-

ciplinary excellence builds on disciplinary excellence. (2) Successful interdisciplinary work establishes powerful pull factors for researchers at all levels. (3) The establishment of a successful interdisciplinary working context depends on the relevant experience and enthusiasm of LEAD's leadership.

These principles help to overcome typical challenges in interdisciplinary research. For instance, LEAD brings together education sciences and psychology through designing randomized field studies that combine psychological process analyses with a focus on external validity. At the intersection of linguistics, psychology, and education sciences, LEAD brings together theoretical and computational linguistic research on language acquisition and expertise in study designs and psychometric analyses. Moreover, at the intersection of sociology/economics and education sciences, LEAD analyzes the interplay of individual, social, institutional, and contextual factors at the transition from school to work, and predicts the long-term consequences of students' academic and vocational biographies and their academic, motivational, and social resources (see figure 1).

The six LEAD research fields, which have proved to be highly productive in Tübingen, are rooted in specific disciplines and are characterized by different approaches used to examine the causes and consequences of learning, achievement, and life course development. Furthermore, the research fields vary with respect to primary interest and the designs and data analysis techniques favored. More information on the participating disciplines and key areas of current interdisciplinary work is provided in the following chapters.



LEAD brings together more than 100 scientists from six different highly productive research fields.





THE LEAD STARTING POINT

EDUCATION SCIENCES

MEMBERS

Karin Berendes
 Christiane Bertram
 Ulrike Cress
 Benjamin Fauth
 Caterina Gawrilow
 Jessika Golle
 Richard Göllner
 Nicolas Hübner
 Augustin Kelava
 Katharina Lambert
 Johanna Marder
 Benjamin Nagengast
 Kerstin Oschatz
 Bernhard Schmidt-Hertha
 Josef Schrader
 Kathleen Stürmer
 Maike Tibus
 Ulrich Trautwein
 Nele Usslepp
 Tamar Voss

A central goal of LEAD is the interdisciplinary and systematic attempt to enlarge, enrich, and improve existing research on education. In this attempt, LEAD's starting point was a modern version of education sciences widely known as empirical education research ("Empirische Bildungsforschung") in Germany. This modern version of education sciences focuses on statistical analyses of individual, institutional and social determinants of educational outcomes, including achievement, motivation, psychosocial adjustment, and personality.

A main topic is the differential effectiveness of various institutionalized learning environments (e.g., schools, universities, vocational training, adult and continuing education) and non-institutionalized learning settings (e.g., modern web communities), and the increasing interconnectedness among them. This research field has its theoretical basis in classical and contemporary thinking on educational effectiveness, and the interplay between the individual capacity for learning and the affordances and constraints of the learning environment.

In terms of research designs, large-scale non-experimental studies with an emphasis on assessment, longitudinal panel studies, as well as evaluations of educational reforms and randomized controlled field studies play an important role.

Research findings from this central research field in LEAD can be of critical importance for several reasons. Firstly, this research oftentimes directly addresses the questions frequently posed by education policymakers and educators: How successful is a certain learning environment? How can the achievement gap between high-

and low-achieving students be closed? Secondly, studies in this area are typically characterized by high ecological validity. This is crucial if, for instance, a study has direct implications for a certain reform measure, e.g., for the introduction of a new learning environment.

At the same time, it is clear that this research field can only partially address the many pressing challenges of evidence-oriented education—specifically when education sciences proceed from diagnosing problems to providing causal explanations and proposing intervention programs. As a result, most research projects in education sciences within LEAD are interdisciplinary and combine theories and constructs from psychology, education and sociology.

In the following, three research strands that characterize education sciences in Tübingen are described. The **intended and unintended effects of educational reforms** are studied by using data from large school achievement studies. Our systematic research program on **teaching effectiveness and teacher competencies** reflects the fact that teachers and classroom process quality are a main determinant of differential outcomes in terms of achievement and student motivation. Finally, the effects of **enrichment offers for talented students at elementary level** are studied by a combination of experimental and non-experimental approaches.



EFFECTS OF EDUCATIONAL POLICY REFORMS IN UPPER SECONDARY SCHOOL



LEAD scientists presenting the findings of their study at the Ministry of Education, Youth and Sports of Baden-Württemberg.

TEAM

Nicolas Hübner
Benjamin Nagengast
Kerstin Oschatz
Ulrich Trautwein
Eike Wille

Reforms are a major instrument of educational administration to shape and influence educational practice and improve educational effectiveness and quality. Scientific evaluation of intended and potentially unintended effects of such reforms is of major importance for a sustainable and responsible education policy.

In three studies, we evaluated the effects of such policy reforms in upper secondary schools in Germany, implemented in the first decade of the new millennium. In a first study, we had a closer look at effects of a reform to compress overall school time at the *Gymnasium* (the highest academic track in the German school system) from nine (G9) to eight years (G8), using data of the Additional Study Baden-Württemberg from the National Educational Panel Study (NEPS; Blossfeld, Roßbach, & von Maurice, 2011).

Comparing data of two student cohorts before the reform with data of two cohorts after the reform ($N = 5,210$), we found no effects of compressing overall school time on competencies in mathematics, physics

or leisure time. However, students in G8 cohorts performed lower in English reading and biology. Furthermore, students claimed that they felt more stressed and less healthy compared to G9 students.

In a second study, we analyzed potentially differential effects for males and females of a German statewide educational reform that required all students to take advanced math courses. Our aim was to analyze the effects that the reform had on math achievement, math self-concept, vocational interests, and field of study at university. To this end, we compared data from 4,730 students before the reform and 4,715 students after the reform in one German state.

We tested effects of gender and cohort on math achievement, math self-concept, realistic and investigative vocational interests, and the choice of STEM university subjects two years after high school. Whereas gender differences in math achievement decreased, differences between boys and girls in math self-concept and realistic and investigative vocational interests increased (see figure 8).

In the third study, we evaluated effects of a similar upper secondary school reform in a different state, located in eastern Germany (Thuringia). We used data of the Additional Study Thuringia published by the NEPS and compared the first cohort before with the first cohort after the reform (N = 2,274). In contrast to the results found in Baden-Württemberg, we did not find any major effects of the reform on average student achievement. However, results indicate that whereas boys' achievement and self-concept in English was higher after the reform, girls showed a lower self-concept in mathematics afterwards.

Results of these studies are in line with an increasing number of studies that showed that reform effects are oftentimes smaller than expected or not identifiable at all and that reforms might even be accompanied by unintended side-effects. These findings highlight the need for education policy to initiate educational evaluations before, during and after implementation of systemic reforms.

CENTRAL PUBLICATIONS

Hübner, N.*, Wille, E.*, Cambria, J., Oschatz, K., Nagengast, B., & Trautwein, U. (2017). Maximizing gender equality by minimizing course choice options? Effects of obligatory coursework in math on gender differences in STEM. *Journal of Educational Psychology*. Advance online publication. doi:10.1037/edu0000183 *The first two authors contributed equally to this work and are listed in alphabetical order.

Hübner, N., Wagner, W., Kramer, J., Nagengast, B., & Trautwein, U. (2017). Die G8-Reform in Baden-Württemberg: Leistungen, Wohlbefinden und Freizeitverhalten vor und nach der Reform. [The G8 reform in Baden-Württemberg: Competencies, wellbeing and leisure time before and after the reform]. *Zeitschrift für Erziehungswissenschaft*. Advance online publication. doi: 10.1007/s11618-017-0737-3

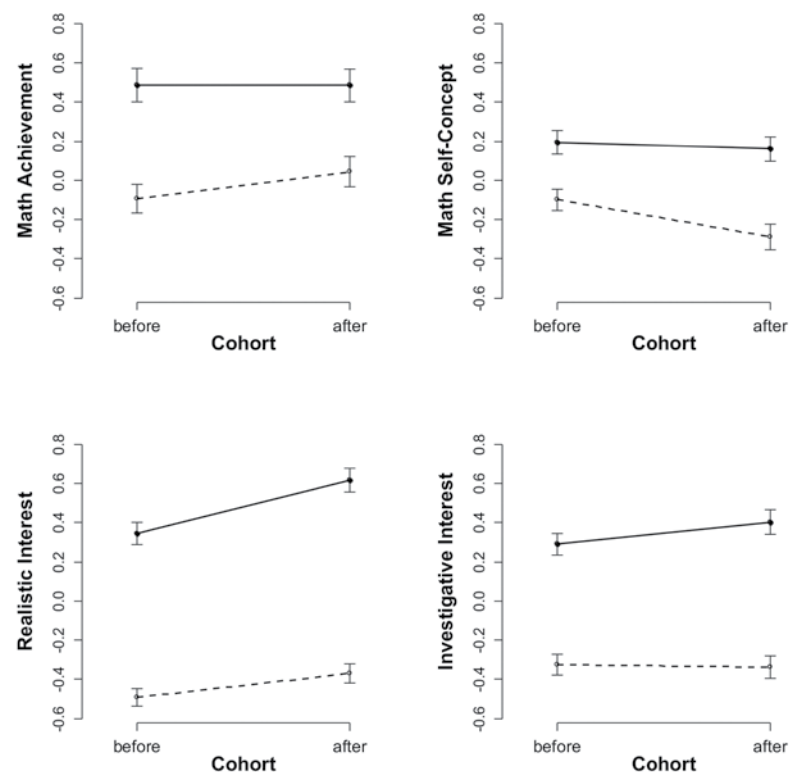

Figure 8. Plots of the moderating effect of gender on the relation between reform and math achievement, math self-concept, realistic interest, and investigative interest with 95% confidence intervals for students before and after the upper secondary school reform in Baden-Württemberg. The dependent variables are presented in standard deviation units.



TEACHING QUALITY AND TEACHERS' PROFESSIONAL COMPETENCE

TEAM

Benjamin Fauth
Richard Göllner
Verena Hoehne
Johanna Marder
Fabian Ruth
Kathleen Stürmer
Ulrich Trautwein
Thamar Voss

Recent research has identified teaching quality and the professional competence of teachers as key factors for students' academic and motivational development. Global factors of classroom process quality, such as cognitive activation, individual support, and classroom management, seem to be more important for student development than specific teaching practices (Fauth, Decristan, Rieser, Klieme, & Büttner, 2014b; Decristan, Klieme, Kunter, Hochweber, Büttner, Fauth et al., 2015; Kunter & Trautwein, 2013; Kunter & Voss, 2013).

Empirical studies confirmed that these basic dimensions of teaching quality are crucial for a variety of student outcomes such as achievement, motivation, and self-regulated learning (Kunter & Voss, 2013; Fauth et al., 2014a; 2014b; Rieser, Naumann, Decristan, Fauth, Klieme, & Büttner, 2016). Teachers' ability to provide high-quality instruction has been conceptualized in the model of teaching-specific professional competence (Voss & Kunter, 2013; Voss, Kunina-Habenicht, Hoehne, & Kunter, 2015). In particular, LEAD research scientists identified teachers' beliefs and teachers' general pedagogical/psychological knowledge as strong predictors of teaching quality (Voss, Kunter, Seiz, Hoehne, & Baumert, 2014; Seiz, Voss, & Kunter, 2015).

Despite these important substantive findings, how teaching quality can best be assessed is still a largely unresolved question. In particular, quality ratings provided by students are subject to an ongoing debate (Fauth et al., 2016). LEAD researchers contributed to this discussion with several internationally visible articles. Wagner, Göllner, Helmke, Trautwein, and Lüdtke (2013) showed that the construct validity

of student ratings is high but not perfect. Applying multilevel structural equation modeling to data from a large-scale German study, the authors examined the dimensionality and the generalizability of assessments across different domains.

Using similar methods, Fauth et al. (2014b) confirmed that even third-graders are able to distinguish between the three basic dimensions of teaching quality in survey-based assessments. However, in the same sample, student ratings correlated only slightly with ratings by teachers and external observers, particularly in the area of cognitive activation (Fauth et al., 2014a).

Wagner, Göllner, Werth, Voss, Schmitz, and Trautwein (2016) found that such inconsistencies can be explained by the instability of ratings over time. By using a manifest-latent, state-trait model, the authors demonstrated that the agreement among teacher and student ratings was higher for time-consistent rating components compared to ratings taken at single measurement time points.

CENTRAL PUBLICATIONS

Decristan, J., Klieme, E., Kunter, M., Hochweber, J., Büttner, G., Fauth, B., Hondrich, A. L., Rieser, S., Hertel, S., & Hardy, I. (2015). Embedded formative assessment and classroom process quality: How do they interact in promoting students' science understanding? *American Educational Research Journal*, *52*, 1133–1159.

Fauth, B., Decristan, J., Rieser, S., Klieme, E., & Büttner, G. (2014). Student ratings of teaching quality in primary school: Dimensions and prediction of student outcomes. *Learning and Instruction*, *29*, 1–9. doi:10.1016/j.learninstruc.2013.07.001

Fauth, B., Decristan, J., Rieser, S., Klieme, E., & Büttner, G. (2014). Grundschulunterricht aus Schüler-, Lehrer- und Beobachterperspektive: Zusammenhänge und Vorhersage von Lernerfolg. [Elementary education from a student's, teacher's and observer's perspective: Interrelations and prediction of learners' success]. *Zeitschrift für Pädagogische Psychologie*, *28*, 127–137.

Fauth, B., Decristan, J., Rieser, S., Klieme, E., & Büttner, G. (2016). Urteile zur Unterrichtsqualität von Grundschüler/innen: Mehr als „Ich mag meine Lehrerin“? [Judgments on the teaching quality by primary school students: More than “I like my teacher”?]. In K. Liebers, B. Landwehr, S. Reinhold, S. Riegler, R. Schmidt (Hrsg.), *Facetten grundschulpädagogischer und grundschuldidaktischer Forschung*. Wiesbaden: Springer.

Kunter, M., & Voss, T. (2013). The model of instructional quality in COACTIV: A multicriteria analysis In M. Kunter, J. Baumert, W. Blum, U. Klusmann, S. Krauss & M. Neubrand (Eds.), *Cognitive activation in the mathematics classroom and professional competence of teachers – results from the COACTIV project* (pp. 97–124). New York: Springer.

Rieser, S., Naumann, A., Decristan, J., Fauth, B., Klieme, E., & Büttner, G. (2016). The connection between teaching and learning: Linking teaching quality and metacognitive strategy use in primary school. *British Journal of Educational Psychology*. Advance online publication. doi:10.1111/bjep.12121

Seiz, J., Voss, T., & Kunter, M. (2015). When knowing is not enough – the relevance of teachers' cognitive and emotional resources for classroom management. *Frontline Learning Research*, *3*. Retrieved from <http://journals.sfu.ca/flr/index.php/journal/article/view/141/238>

Voss, T., Kunina-Habenicht, O., Hoehne, V., & Kunter, M. (2015). Stichwort Pädagogisches Wissen von Lehrkräften: Empirische Zugänge und Befunde. [Keyword educational knowledge of teachers: Empirical approaches and findings]. *Zeitschrift für Erziehungswissenschaft*, *18*, 187–223. doi:10.1007/s11618-015-0626-6

Voss, T., & Kunter, M. (2013). Teachers' general pedagogical/psychological knowledge. In M. Kunter, J. Baumert, W. Blum, U. Klusmann, S. Krauss & M. Neubrand (Eds.), *Cognitive activation in the mathematics classroom and professional competence of teachers – results from the COACTIV project* (pp. 207–228). New York: Springer.

Voss, T., Kunter, M., Seiz, J., Hoehne, V., & Baumert, J. (2014). Die Bedeutung des pädagogisch-psychologischen Wissens von angehenden Lehrkräften für die Unterrichtsqualität. [The importance of the pedagogic-psychological knowledge of prospective teachers for the teaching quality]. *Zeitschrift für Pädagogik*, *60*, 184–201.

Wagner, W., Göllner, R., Helmke, A., Trautwein, U., & Lüdtke, O. (2013). Construct validity of student perceptions of instructional quality is high, but not perfect: Dimensionality and generalizability of domain-independent assessments. *Learning and Instruction*, *28*, 1–11. doi:10.1016/j.learninstruc.2013.03.003

Wagner, W., Göllner, R., Werth, S., Voss, T., Schmitz, B., & Trautwein, U. (2016). Student and teacher ratings of instructional quality: Consistency of ratings over time, agreement, and predictive power. *Journal of Educational Psychology*, *108*, 705–721. doi:10.1037/edu0000075



ENRICHMENT COURSES FOR GIFTED PRIMARY SCHOOLCHILDREN

TEAM

Verena Fiebig
 Jessika Golle
 Evelin Herbein
 Verena Hoehne
 Jennifer Müller
 Kerstin Oschatz
 Franziska Rebholz
 Julia Schiefer
 Maike Tibus
 Ulrich Trautwein

Enrichment programs are one of the most prominent approaches to fostering gifted students. Such programs are characterized by learning opportunities that go beyond the school curriculum, either by a deeper or broader examination of topics that are already included in the regular curriculum or by learning new topics outside of the regular curriculum (Newland, 1976). One example of a statewide extracurricular enrichment program that aims at fostering gifted students comprehensively is the Hector Children's Academy Program. Across the entire German state of Baden-Württemberg, gifted primary schoolchildren are fostered by a wide range of course topics in 61 local units (the so-called Hector Children's Academies).

In close collaboration with an interdisciplinary research team, including the expertise of educational scientists, specialized pedagogues, psychologists, content specialists and teachers, enrichment courses are developed to meet the needs of gifted children. The so-called Hector Core Courses cover a wide range of topics from public speaking skills, understanding science, especially in the STEM-subjects, and chemistry to mathematical competence and musical composition techniques in combination with mathematical tasks.

After developing and piloting, every course is evaluated and implemented in other Hector Children's Academies. Therefore, a qualification program for instructors is designed for each course. In the most recent phase of course development, practitioners were asked to conceptualize new Hector Core Courses together with the research team. The new courses also place emphasis on STEM topics, but aim at fostering different skills such as special abilities.



At the Hector Children's Academies gifted students learn to compose with Lego bricks.

The Hector Core Courses have been developed and their effectiveness investigated in several studies since 2013, commonly as randomized controlled trials. Besides the random group allocation, it is challenging to use valid and reliable measurement instruments for the target outcomes and particularly for this age group. Therefore, new measurement instruments have to be developed (e.g., Schiefer, Golle, & Oschatz, 2016; Schröders, Schipolowski, Zettler, Golle, & Wilhelm, 2016).

The results of recent studies have shown that the courses had a positive effect on the children participating in the courses compared to a control group. They improved e.g., their public speaking skills (Herbein et al., 2016), understanding of science (Schiefer, Golle, Tibus, et al., 2016), or mathematical skills (Rebholz & Golle, in press). However, the aim is to optimize the courses continuously, and thus, further effectiveness studies are planned as well as additional studies to examine differential course effects.

In addition to expanding the diverse professional enrichment program, a further aim of the project is to examine and support teachers' nominations of gifted

children. Checklists are provided and the aim is to increase the number of nominated students who are talented but do not necessarily have good school grades.

Since 2012 several studies have been conducted to examine the nomination of gifted children (Kornmann, Zettler, Kammerer, Gerjets, & Trautwein, 2015; Rothenbusch, Zettler, Voss, Lösche, & Trautwein, 2016), different learning environments (J. Kornmann et al., 2016), the effectiveness of the entire enrichment program (Golle et al., 2016) as well as of single courses (see above).

Future perspectives focus on enlarging the network, developing more Hector Core Courses in cooperation with content specialists and providing professional trainings for course instructors.

COOPERATION PARTNERS

Hanna Beißert, Katharina Grunwald, Marcus Hasselhorn, Patrick Lösche (Deutsches Institut für Internationale Pädagogische Forschung)

Peter Gerjets, Korbinian Möller, Uwe Oestermeier (Leibniz-Institut für Wissensmedien)

Mathias Lutz, Marcus Rehm (Pädagogische Hochschule Heidelberg)

Nora Newcombe (Department of Psychology, Temple University Philadelphia, and PI of the Spatial Intelligence and Learning Center (SILC))

Ingo Zettler (Institute for Psychology, University of Copenhagen)

CENTRAL PUBLICATIONS

Kornmann, J., Kammerer, Y., Anjewierden, A., Zettler, I., Trautwein, U., & Gerjets, P. (2016). How children navigate a multiperspective hypermedia environment: The role of spatial working memory capacity. *Computers in Human Behavior*, *55*, 145–158.

Kornmann, J., Zettler, I., Kammerer, Y., Gerjets, P., & Trautwein, U. (2015). What characterizes children nominated as gifted by teachers? A closer consideration of working memory and intelligence. *High Ability Studies*, *26*, 75–92. doi:10.1080/13598139.2015.1033513

Rothenbusch, S., Zettler, I., Voss, T., Lösche, T., & Trautwein, U. (2016). Exploring reference group effects on teachers' nominations of gifted students. *Journal of Educational Psychology*, *108*, 883–897. doi:10.1037/edu0000085

Schroeders, U., Schipolowski, S., Zettler, I., Golle, J., & Wilhelm, O. (2016). Do the smart get smarter? Development of fluid and crystallized intelligence in 3rd Grade. *Intelligence*, *59*, 84–95. doi:10.1016/j.intell.2016.08.003.

SUPPORTED BY







INTERSECTION 1

LEARNING PROCESSES AND OUTCOMES

MEMBERS

Ulrike Cress
 Caterina Gawrilow
 Jacquelynne Eccles
 Benjamin Fauth
 Verena Fiebig
 Hanna Gaspard
 Peter Gerjets
 Hanna Granz
 Isabelle Häfner
 Friedrich Hesse
 Emely Hoch
 Verena Hoehne
 Juliane Kant
 Barbara Kaup
 Augustin Kelava
 Heide Kneißler
 Fabian Lang
 Thomas Lösch
 Ulrich Ludewig
 Korbinian Möller
 Jennifer Müller
 Benjamin Nagengast
 Hans-Christoph Nürk
 Christoph Randler
 Franziska Rebholz
 Juliane Richter
 Kai Sassenberg
 Katharina Scheiter
 Julia Schiefer
 Katrin Schleinschok
 Steffen Schmidgall
 Josef Schrader
 Stephan Schwan
 Gorden Sudeck
 Michèle Suhlmann
 Maike Tibus
 Ulrich Trautwein
 Réka Vágvölgyi
 Eike Wille
 Franz Wortha

This intersection is situated at the interface of education sciences and various psychological disciplines. Researchers in this intersection investigate the cognitive, social, and motivational determinants of educational outcomes with the aim to better understand the psychological foundations of learning. In particular, we attempt to answer the following questions: Which psychological variables are associated with high and low achievement? How important are motivation and self-regulation for learning, and how can they be enhanced? How can the potential of digital technology be fully exploited for learning?

To address these questions, we employ methodologies ranging from correlational to experimental approaches. Experimental research in the lab and in the classroom is conducted to investigate the causal impact of psychological constructs on student learning. Correlational data from

large samples are analyzed to describe the manifold relationships among factors that affect student learning in and outside the classroom. Methodologies for tracing information processes at a high level of resolution, such as eye tracking, verbal protocols or log file analyses, are deployed to describe mechanisms underlying these relationships. Importantly, studies conducted in this intersection go beyond describing the psychological foundations of learning by also designing and evaluating interventions that focus on fostering beneficial learning processes.

One of our major research areas is **competence in math and sciences**. Here, we address the factors that are associated with high and low achievement in these fields and the question of how achievement can be improved. Some research scientists in this field develop tools to assess competencies related to math and sciences with



In LEAD's intersection 1 scientists investigate how to fully exploit the potential of modern media for learning.

FINISHED DISSERTATIONS

Gaspard, H. (2015). *Promoting value beliefs in mathematics: A multidimensional perspective and the role of gender.* University of Tübingen.

Häfner, I. (2015). *Investigating associations between family background and students' academic outcomes: The role of parents' motivation.* University of Tübingen.

Kant, J. (2017). *Fostering the acquisition of scientific reasoning with video modeling examples and inquiry tasks.* University of Tübingen.

Lösch, T. (2017). *Perceiving achievement in schools: How do self-appraisals, peer appraisals and achievement relate to each other?* University of Tübingen.

Richter, J. (2017). *Signaling text-picture relations in multimedia learning: The influence of prior knowledge.* University of Tübingen.

Schiefer, J. (2017). *Promoting and measuring elementary school children's understanding of science.* University of Tübingen.

children and adults while others design and evaluate interventions targeted at promoting these competencies.

Research on **motivation and self-regulation** focuses on the predictive power of motivation and self-regulation for educational outcomes in the short and long term and how they can be fostered. This includes experiments that investigate the effectiveness of interventions in fostering motivation and self-regulated learning in the lab as well as in the classroom. Researchers in this area also investigate the influence of social-psychological processes on motivation and academic success.

In our research on **modern media environments**, we design and evaluate digital media environments and tools to assess students' and teachers' competencies. We also investigate how technology (e.g., tablet computers) is integrated in classrooms in Baden-Württemberg by looking at teachers' attitudes and knowledge as influencing factors, their actual media use, and students' learning results as outcomes in a randomized controlled field study that incorporates a longitudinal perspective.



eChemBook: A DIGITAL TEXTBOOK FOR CHEMISTRY EDUCATION

TEAM

Juliane Richter
Katharina Scheiter

SUPPORTED BY



Digital learning materials such as digital textbooks are finding increased use in the classroom. Little is known, however, about their design. The project funded by the German Research Foundation (DFG) was designed to integrate scientific insights from various fields of research (e.g., text comprehension, motivation, multimedia learning) and apply them to the development of a prototype of a digital textbook entitled eChemBook. The project consists of research scientists from chemistry education, instructional design/multimedia research as well as industrial partners (Schroedel Westermann, a textbook publisher and SMART Technologies, a manufacturer of interactive whiteboards).

Firstly, a questionnaire-based study involving more than 300 science teachers across Germany was conducted, inquiring about their teaching-related media use and their needs and expectations regarding a digital chemistry textbook. Secondly, based on the questionnaire results and evidence from research on instructional design and science education, an eChemBook prototype on the Particle Model of Matter was developed and empirically tested in a field study involving 396 high school students. Thirdly, design recommendations regarding the content, layout, navigation, and instructional design were documented for textbook authors.

Authors then developed a second textbook unit about Dalton's Atomic Model by using the recommended design measures. In a fourth step, teachers of 26 classes used both eChemBooks for class teaching during the school year and gave feedback about the type of use and potential difficulties. Again, student learning outcomes were assessed.

Within the eChemBook project, a PhD project focused on the effectiveness of one particular instructional design measure, namely the use of signals in multimedia materials. Signaling measures such as color coding of related elements highlight correspondences between text and picture and are supposed to support learners in integrating verbal and pictorial information.

A meta-analysis was first conducted to determine the effectiveness of multimedia signaling (Richter, Scheiter, & Eitel, 2016). Results showed that there was a small to medium overall effect in favor of signaling; moreover, the signaling effect was determined by learners' prior knowledge: Low prior knowledge (LPK) learners performed better when signals were present in the materials, whereas high prior knowledge (HPK) learners were not supported by signals, thereby revealing evidence for an expertise reversal effect.

An experimental field study more thoroughly investigated the influence of prior knowledge on the effectiveness of signaling in a real school setting with an instructional topic from the curriculum. The results confirmed the expertise reversal effect revealed in the meta-analysis, whereby HPK learners were even hindered in learning when signals were present. Finally, a laboratory study replicated the expertise reversal effect and used eye-tracking data to test its underlying mechanisms.

COOPERATION PARTNERS

Nina Ulrich and Sascha Schanze (Leibniz Universität Hannover)

CENTRAL PUBLICATIONS

Richter, J., Scheiter, K., & Eitel, A. (2016). Signaling text-picture relations in multimedia learning: A comprehensive meta-analysis. *Educational Research Review*, 17, 19–36. doi:10.1016/j.edurev.2015.12.003.



PARENTS' INFLUENCE ON STUDENTS' STEM CAREER PATHS

TEAM

Isabelle Häfner
Benjamin Nagengast
Ulrich Trautwein

Family background is a crucial factor for the development of student motivation and academic outcomes. Eccles' (2007) parent socialization model, one of the best established theories investigating family influences on students' academic outcomes, assumes that parental perceptions of student ability (how good is my child?) and parental value beliefs (how useful is it for my child?) influence students' own motivational beliefs and thereby academic performance as well. It is, however, unclear whether parents' motivational beliefs still play a role in the academic performance of their children after middle school. Thus, we investigated how parents' and students' motivational beliefs interrelate and shape student performance in science, technology, engineering, and mathematics (STEM) from middle school through college.

The sample consisted of 301 U.S. high school students and their parents from the longitudinal Wisconsin Study of Families and Work (WSFW; for details of recruitment,

see Hyde, Klein, Essex, & Clark, 1995). Data from the students and their mothers was assessed at the 7th and 11th-12th grade via self-reports. In addition, students' STEM achievement was obtained at the 10th grade; students' filled out questionnaires after their second year in college.

We found that mothers' perceptions of their children's ability in the 7th grade predicted how useful students perceived STEM subjects to be for themselves, how good students' perceived themselves to be in STEM subjects, how many STEM courses students chose, and their STEM achievement in the 11-12th grade. In turn, students' STEM achievement in the 10th grade predicted mothers' perceived usefulness of STEM subjects for their child in the 12th grade. Regarding students' college outcomes, the mothers' perceived usefulness of STEM subjects for their child predicted the students' future STEM motivation, the number of STEM courses taken and students' STEM career aspirations in college.

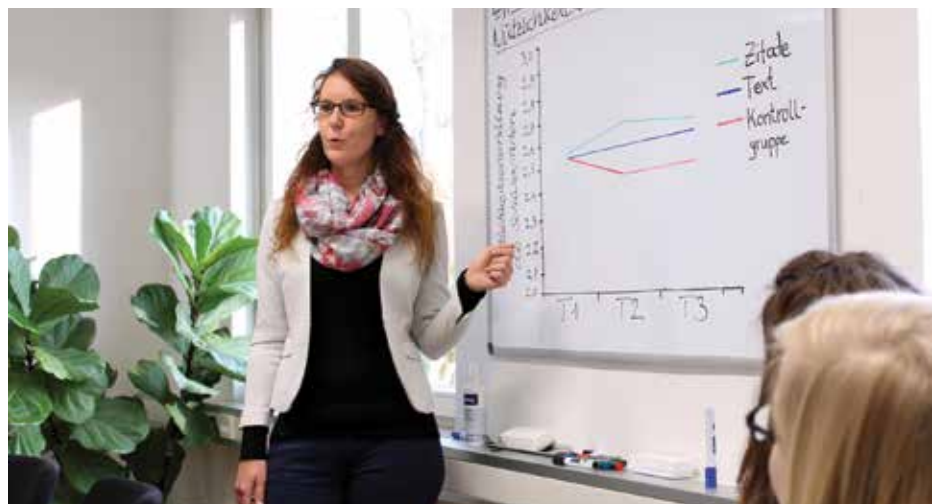

LEAD PhD candidate Isabelle Häfner investigated how parents' motivational beliefs shape student performance in STEM.

Our study highlighted the importance of the mother's motivational beliefs for the student's academic motivation, behavior, and achievement. Thus, parents have a strong influence on their children and this influence ends neither when their children become teenagers nor when they graduate from high school. To conclude, our results yield new insights into ways through which parents influence their children's educational pathway from middle school through high school graduation to college.

COOPERATION PARTNERS

Chris Hulleman (University of Virginia, USA)
 Judy Harackiewicz, Janet Hyde (University of Wisconsin-Madison, USA)
 Chris Rozek (University of Chicago, USA)

CENTRAL PUBLICATIONS

Häfner, I., Flunger, B., Dicke, A.-L., Gaspard, H., Brisson, B. M., Nagengast, B., & Trautwein, U. (in press). A Robin Hood effect on math motivation: Family background moderates the effects of relevance interventions. *Developmental Psychology*.

Häfner, I., Flunger, B., Dicke, A.-L., Gaspard, H., Brisson, B. M., Nagengast, B., & Trautwein, U. (2017). The role of family characteristics for students' academic outcomes: A person-centered approach. *Child Development*. doi:10.1111/cdev.12809

THIRD-PARTY FUNDS ORIGINATING FROM THIS PROJECT

Häfner, I.: Familiäre motivationale Ressourcen als Determinanten von motivationalen Überzeugungen und beruflichen Aspirationen von Schülerinnen und Schülern. [Family motivational resources as determinants of motivational convictions and professional aspirations of students]. Baden-Württemberg Stiftung, 42.007 €, 01/2017–12/2017.

Goellner, R., Häfner, I., Flunger, B.: Förderung der Lern- und Leistungsmotivation für einen erfolgreichen Übergang in die Berufsausbildung bei Schülerinnen und Schülern von Haupt- und Werkrealschulen in Baden-Württemberg. [Promoting learning and achievement motivation for a successful transition into vocational training for students from secondary schools in Baden-Württemberg]. Baden-Württemberg Stiftung, 11.662 €, 01/2015–10/2016.

SUPPORTED BY

DFG Deutsche
 Forschungsgemeinschaft



Baden-Württemberg





PROMOTING MOTIVATION FOR MATHEMATICS IN THE CLASSROOM

TEAM

Hanna Gaspard
Isabelle Häfner
Benjamin Nagengast
Ulrich Trautwein

Math plays a crucial role in educational and occupational success. Yet student motivation in math decreases dramatically during adolescence. Expectancy value theory by Eccles et al. (1983), one of the best established motivational theories, assumes that students' learning behavior is influenced by their expectancy of success ("Can I do it?") and their subjective task value ("Why should I do it?"). Interventions based on expectancy value theory aim to foster students' motivation by increasing the perceived usefulness of the learning material. In the "Motivation in Mathematics" (MoMa) study, we tested whether ninth-grade students' motivation for learning mathematics could be enhanced by utility value interventions in the classroom.

A total of 1916 students out of 82 ninth grade classrooms from 25 academic-track

schools participated in this study. The classes were randomly assigned to one of two intervention conditions or a waiting control condition. The intervention was a 90-minute lesson on the relevance of mathematics. After a psychoeducational presentation, students were either asked to evaluate quotations of young adults talking about the usefulness of math ("quotation conditions") or were asked to write an essay on the relevance of math in their lives ("text condition"). To evaluate the effects of the interventions, student motivation was assessed via self-reports before the intervention and six weeks and five months afterwards. Additionally, student achievement was assessed and parents and teachers were asked to fill out questionnaires.

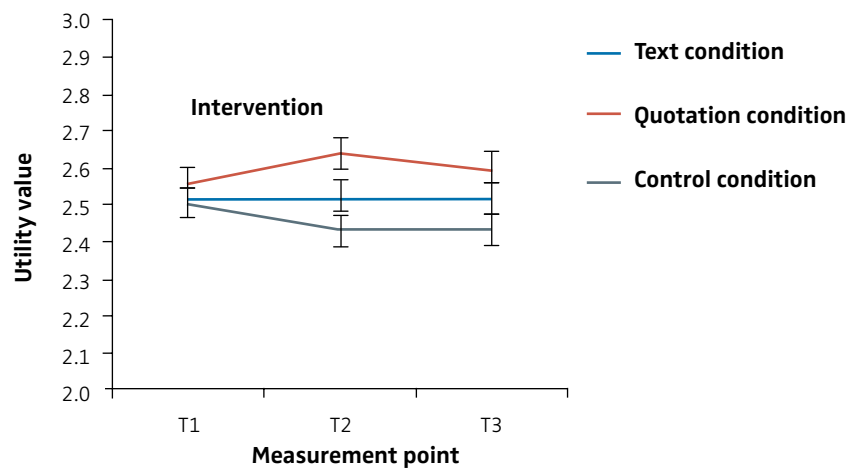

Figure 9. Utility value in mathematics at pretest (T1), posttest (T2), and follow-up (T3) in the intervention conditions and control condition. Error bars represent 95% confidence intervals.

SUPPORTED BY



Baden-Württemberg



COOPERATION PARTNERS

Jacquelyne Eccles (University of California, Irvine, USA)
Chris Hulleman (University of Virginia, USA)

CENTRAL PUBLICATIONS

Gaspard, H., Häfner, I., Parrisius, C., Trautwein, U., & Nagengast, B. (2016). Assessing task values in five subjects during secondary school: Measurement structure and mean level differences across grade level, gender, and academic subject. *Contemporary Educational Psychology*. Advance online publication. doi: 10.1016/j.cedpsych.2016.09.003

Gaspard, H., Dicke, A.-L., Flunger, B., Brisson, B. M., Häfner, I., Nagengast, B., & Trautwein, U. (2015). Fostering adolescents' value beliefs for mathematics with a relevance intervention in the classroom. *Developmental Psychology*, 51, 1226–1240.

Gaspard, H., Dicke, A.-L., Flunger, B., Häfner, I., Brisson, B. M., Trautwein, U., & Nagengast, B. (2016). Side effects of motivational interventions? Effects of an intervention in math classrooms on motivation in verbal domains. *AERA Open*, 2, 1–14.

THIRD-PARTY FUNDS ORIGINATING FROM THIS PROJECT

Gaspard, H.: Förderung von Wertüberzeugungen im Mathematikunterricht. [Promoting utility values in mathematics.] Elite program for postdoctoral students, Baden-Württemberg Stiftung, 110.000 €, 01/2016–12/2018.





INTERSECTION 2

EDUCATIONAL NEUROSCIENCE

MEMBERS

Christina Artemenko
 Silke Bieck
 Friederike Blume
 Sergio Cervera Torres
 Ulrike Cress
 Birgit Derntl
 Thomas Dresler
 Ann-Christine Ehlis
 Andreas J. Fallgatter
 Mirjam Frey (née Wasner)
 Caterina Gawrilow
 Peter Gerjets
 Sebastian Grissmann
 Justin Hudak
 Enkelejda Kasneci
 Augustin Kelava
 Tanja Krumpe
 Philipp Mock
 Korbinian Möller
 Benjamin Nagengast
 Manuel Ninaus
 Hans-Christoph Nürk
 Tobias J. Renner
 Wolfgang Rosenstiel
 Susana Ruiz Fernández
 Carina Walter

Educational Neuroscience – a modern interdisciplinary research field integrating cognitive psychology, neuroscience, medicine, computer science, and education sciences – aims at bridging basic research and educational application. In this intersection, questions such as “Where are numbers represented in the brain?”, “Can we detect a learner’s workload by means of brain activation?” and “Does it influence school achievement when children learn to self-regulate their brain?” are pursued with the idea to inform people in educational practice.

We employ a multi-methodological approach, tailoring the method to the research question at hand. This includes electroencephalography (EEG), functional magnetic resonance imaging (fMRI), near-infrared spectroscopy (NIRS), transcranial electric stimulation (tES), virtual reality (VR), and eye tracking (ET). Additionally, we investigate brain-computer interface (BCI) applications, allowing for the implementation of adaptive multimedia and learning environments. The principal investigators of the intersection have contributed substantially to our knowledge of the neurocognitive processes and representations underlying learning and education.

In the research field of **numerical cognition and arithmetic learning**, we are investigating neurocognitive processes in ecologically more valid settings. Hence, by employing fNIRS, we can use paradigms enabling participants to sit at their desk in neurocognitive studies as if they were in a classroom. Furthermore, we developed and evaluated embodied learning environments to effectively increase academic learning.

In the field of **applied computer science**, we aim at identifying neural or behavioral signatures of learner states such as cognitive workload or emotional states. Therefore, we analyze EEG data by means of machine learning algorithms, but also use high-resolution sensor data from touchscreen handling. Classifying these data may help to design adaptive learning environments tailored to the needs of the learner.

In the research field of **neuroscientifically guided intervention**, we introduce an NIRS-based neurofeedback training in a VR classroom to help school children with ADHD. Neurofeedback aims at tackling neurophysiological as well as cognitive-behavioral deficits, which in turn should improve academic performance in children with ADHD.

FINISHED DISSERTATIONS

Frey, M. (2017). *The significance of finger-based representations for numeric abilities – results of an intervention at the beginning of primary school and differentiation of structural features.* University of Tübingen.

Grissmann, S. (2017). *Investigating the prerequisites for a robust neurotutor: The detection of mixed user states containing working memory load, affective valence and affective dominance.* University of Tübingen.

Mock, P. (2017). *Using low-level sensor data to improve touchscreen interaction.* University of Tübingen.

Walter, C. (2015). *EEG workload prediction in a closed-loop learning environment.* University of Tübingen.



WORKLOAD-ADAPTIVE LEARNING ENVIRONMENTS FOR MATH

TEAM

Peter Gerjets
Tanja Krumpe
Korbinian Möller
Wolfgang Rosenstiel
Carina Walter

Successful learning, particularly in complex domains such as math, presupposes that learners' working memory load is permanently kept within the boundaries of available cognitive resources. Optimal learning conditions are usually characterized by providing challenges for learners without inducing cognitive over- or underload. Therefore, computer-supported learning environments should be adaptive in a way that learners' working memory load is automatically held within an optimal range.

Unfortunately, until now no methods have been available that allow for a continuous workload monitoring required for this type of adaptation. Even worse, current methods for the assessment of cognitive workload (e.g., subjective rating scales or performance measures such as error-

counting) are not only discrete (instead of continuous), but also intrusive and fallible. For instance, errors in learning tasks might go back to cognitive overload, to disengagement or a lack of concentration.

Therefore, more direct online measures of working memory load are needed. Our interdisciplinary project addresses these issues by relying on machine-learning algorithms that were developed in the context of brain-computer interfaces. These algorithms are able to continuously interpret human brain states based on physiological measures from the electroencephalogram (EEG). In a series of studies, we applied this methodology to classify individual learners' working memory load in real time. Using different working memory tasks, such as the N-back task or span tasks, we were able to identify and automatically classify

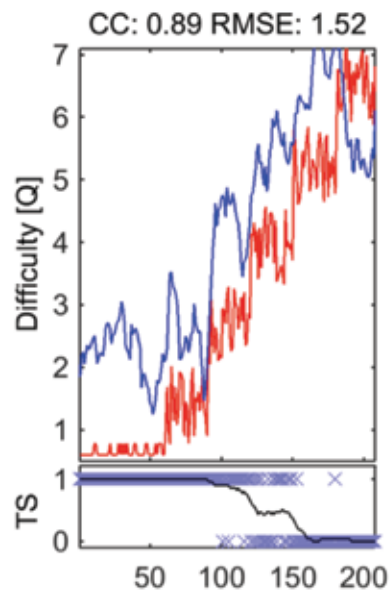

Figure 10. Neural signatures of working-memory load allow for a fine-grained analysis of several workload levels on an individual basis. For instance, the correlation coefficient (CC) between objective task complexity (as measured by a parameter Q , red line) and the working-memory load predicted by a linear ridge regression on features from 17 EEG channels (blue line) in this case is .89. At the bottom of the plot, trials solved (TS) are shown with 1 indicating a correctly solved and 0 reflecting an incorrectly solved problem. Each light blue cross represents one arithmetic problem, while the black line is the smoothed version, depicting the smoothed percentage of correctly solved problems over time.

characteristic neural signatures of working memory load on a single-trial basis.

In further work, we could demonstrate that these signatures can also be used for detecting working memory load when learners engage in more realistic educational tasks such as hypertext reading or solving arithmetic problems. For instance, in a study using seven difficulty levels of arithmetic problems, we could show that the neural signatures of working memory load allowed for a fine grained analysis of several workload levels (see figure 10). In this study, the average correlation between objective task complexity and predicted working memory load based on neural signatures was .74. Based on these promising results, we recently developed the first prototype of a “neuro-tutor”. This tutor in the domain of arithmetic in the octal number system uses a real time EEG-based workload prediction to automatically adapt difficulty levels of training tasks presented to learners.

SUPPORTED BY

WissenschaftsCampusTübingen
Bildung in Informationsumwelten.



Leibniz
Leibniz Association

COOPERATION PARTNERS

Martin Bogdan (Universität Leipzig)
Thorsten Schubert (Universität Halle)
Alexander Soutschek (Universität Zürich)
Thorsten Zander (Technische Universität Berlin)

CENTRAL PUBLICATIONS AND CONFERENCE PROCEEDINGS

Walter, C., Rosenstiel, W., Bogdan, M., Gerjets, P., & Spüler, M. (2016). *Improving arithmetic learning by real-time EEG-based workload adaptation*. Manuscript submitted for publication.

Spüler, M., Walter, C., Rosenstiel, W., Gerjets, P., Moeller, K., & Klein, E. (2016). EEG-based prediction of cognitive workload induced by arithmetic: A step towards online adaptation in numerical learning. *ZDM Mathematics Education, 48*, 267–278. doi:10.1007/s11858-015-0754-8.

Gerjets, P., Walter, C., Rosenstiel, W., Bogdan, M., & Zander, T. O. (2014). Cognitive state monitoring and the design of adaptive instruction in digital environments: Lessons learned from cognitive workload assessment using a passive brain-computer interface approach. *Frontiers in Neuroscience, 8*. doi:10.3389/fnins.2014.00385.

Walter, C., Wolter, P., Spüler, M., Rosenstiel, W., & Bogdan, M. (2014). Towards cross-subject workload prediction. *Proceedings of the 6th International Brain-Computer Interface Conference*, 190–193. doi:10.3217/978-3-85125-378-8-30

Walter, C., Schmidt, S., Rosenstiel, W., Gerjets, P., & Bogdan, M. (2013). Using cross-task classification for classifying workload levels in complex learning tasks. *Proceedings of the 5th Humane Association Conference on Affective Computing and Intelligent Interaction*, 876–881.

THIRD-PARTY FUNDS ORIGINATING FROM THIS PROJECT

Gerjets, P. & Rosenstiel, W.: Brain computer interfaces and workload adaptive informational environments. Leibniz Association (ScienceCampus Tübingen “Informational Environments”), 480.000 €, 01/2013–12/2016.



NEUROCOGNITIVE UNDERPINNINGS OF MATHEMATICAL LEARNING

TEAM

Christina Artemenko
 Silke Bieck
 Thomas Dresler
 Ann-Christine Ehlis
 Mirjam Frey (née Wasner)
 Korbinian Möller
 Manuel Ninaus
 Hans-Christoph Nürk

A basic objective of any school curriculum is learning to deal with numbers and to apply basic arithmetic operations. As numbers are an essential part of our everyday life, failing can result in underachievement accompanied by cognitive and emotional problems. To illustrate the principles of arithmetic learning and education, it is important to identify neural mechanisms associated with numerical processing and calculation. This knowledge also leads to a better understanding of our successful training studies in children, building on concepts such as embodied cognition.

To pursue this goal, different imaging methods are applied in our labs to unravel the underlying neural mechanisms of numerical cognition. As each method has its advantages and limitations, we decide on their use and/or combination based on the research question at hand. First, **functional near-infrared spectroscopy (fNIRS)** measures the participants' blood supply in the brain in an ecologically valid way. As such, the neural correlates of the basic arithmetic operations were identified in adults as well as in schoolchildren, for instance when sitting at a desk and working on arithmetic tasks. In addition, neurocognitive changes due to arithmetic learning were investigated in children during natural development and when induced by training.

Secondly, ongoing **electroencephalography (EEG)** allows investigation of the state of functional neural network activity and top separate specific strategies. Herewith, a shift from slow procedural strategies to faster retrieval was indicated in our training study. In this context, arithmetic training on a web-based platform was evaluated by functional NIRS and EEG so that strategy

changes from procedural to memory-based retrieval could be observed. Thirdly, by means of **functional magnetic resonance imaging (fMRI)** we investigated the contribution of brain structures associated with long-term memory processes in arithmetic fact learning. Accordingly, we identified involvement of hippocampal and retrosplenial areas in arithmetic fact retrieval.

Apart from understanding neural functioning, it is also important to apply such knowledge to interventions, which may not only involve behavioral training, but also more direct neurostimulation approaches. Here, an intramural research grant project was initiated to apply transcranial direct current stimulation (tRNS) to brain regions relevant in numerical cognition and to assist embodied numerical cognition training.



CENTRAL PUBLICATIONS

- Artemenko, C., Daroczy, G., & Nuerk, H.-C. (2015). Neural correlates of math anxiety – an overview and implications. *Frontiers in Psychology*, 6. doi:10.3389/fpsyg.2015.01333
- Artemenko, C., Moeller, K., Huber, S., & Klein, E. (2015). Differential influences of unilateral tDCS over the intraparietal cortex on numerical cognition. *Frontiers in Human Neuroscience*, 9. doi:10.3389/fnhum.2015.00110
- Bahnmueller, J., Dresler, T., Ehlis, A.-C., Cress, U., & Nuerk, H.-C. (2014). NIRS in motion - Unraveling the neurocognitive underpinnings of embodied numerical cognition. *Frontiers in Psychology*, 5. doi:10.3389/fpsyg.2014.00743
- Bloechle, J., Huber, S., Bahnmueller, J., Rennig, J., Willmes, K., Cavdaroglu, S., Moeller, K., & Klein E. (2016). Fact learning in complex arithmetic-the role of the angular gyrus revisited. *Human Brain Mapping*, 37, 3061-3079. doi:10.1002/hbm.23226
- Link, T., Nuerk, H.-C., & Moeller, K. (2014). On the relation between the mental number line and arithmetic competencies. *The Quarterly Journal of Experimental Psychology*, 67, 1597–1613. doi:10.1080/17470218.2014.892517

THIRD-PARTY FUNDS ORIGINATING FROM THIS PROJECT

- Nuerk, H.-C., Haman, M., & Domahs, F. (cooperation partner A.-C. Ehlis): Linguistic influences on numerical cognition: A cross-cultural investigation using natural specificities of Polish and German languages (LingNumCog). German Research Foundation (DFG), 466.590 €, 2016–2019.
- Nuerk, H.-C., & Dresler, T.: Organisation of the Symposium “Neuroeducation of Number Processing”, Hannover. VolkswagenStiftung, 14.100 €, October 2015.
- Nuerk, H.-C., Fischer, M., & Dresler, T.: Moderation and co-organisation of the workshop “Educational Neuroscience of Mathematics” (Satellite Event to KOGWIS 2014), Tübingen. German Research Foundation (DFG), International Scientific Events GZ: NU 265/2-1; LEAD: GSC 1028 and ScienceCampus Tübingen, 13.700 €, October 2014.
- Nuerk, H.-C., Ehlis A.-C. et al.: Neurocognitive on-line adaption and evaluation of a socially interactive web-based learning platform, ScienceCampus Tübingen, 200.000 €, 2013–2016.
- Moeller, K. et al.: Implementation, neurocognitive on-line adaption and evaluation of a socially interactive web-based learning platform for arithmetic”, ScienceCampus Tübingen, 100.000 €, 2013–2015.
- Moeller, K.: EVA-LISA Evaluation eines Learning Analytics Ansatzes für sensorbasiertes adaptives Lernen. [EVA-LISA Evaluation of a learning analytics approach for sensor-based adaptive learning]. Federal Ministry of Education and Research (BMBF), ca. 205.000 €, 2016–2019.
- Cress, U., Nuerk, H.-C., & Moeller, K.: Verkörperlichtes Lernen von Numerosität – Mathe mit der Matte. [Embodied learning of numerosities – Math with the mat]. German Research Foundation (DFG), 220.844 €, 2016–2017.
- Moeller, K. & Klein, E.: On the neuro-cognitive representations involved in fraction processing and its learning. German Research Foundation (DFG), ca. 250.000 €, 2014-2016.
- Cress, U., Moeller, K., Ehlis, A.-C. & Nuerk, H.-C.: Embodied learning of numerosities – Math with the mat, German Research Foundation (DFG), ca. 207.200 €, 2013–2015.
- Obersteiner, A., & Dresler, T.: Förderung des Aufbaus mentaler Repräsentationen von Bruchzahlen zu Beginn der Sekundarstufe: Behaviorale Effekte und neuronale Korrelate. [Promoting the construction of mental representations of fractional numbers at the beginning of the secondary level: Behavioral effects and neural correlates]. German Research Foundation (DFG), ca. 359.800 €, 2018–2020/21.



Junior research group leader Thomas Dresler presents neuroscientific methods with which LEAD identifies neural mechanisms of numerical cognition.



NEUROFEEDBACK TRAINING FOR CHILDREN WITH ADHD

TEAM

Friederike Blume
 Thomas Dresler
 Andreas J. Fallgatter
 Ann-Christine Ehlis
 Caterina Gawrilow
 Justin Hudak
 Jan Kühnhausen
 Tobias J. Renner

Children with attention-deficit/hyperactivity disorder (ADHD) suffer from attention deficits and hyperactive and impulsive behavior; furthermore, they experience these impairments at home with family and friends as well as at school. Studies using near-infrared spectroscopy (NIRS) show that ADHD symptoms and deficits in executive functions (EF) are accompanied by aberrant neurophysiological functioning. Moreover, there is empirical evidence that ADHD symptoms, EF deficits and poor self-regulation contribute to poor school performance although children suffering from ADHD are not less intelligent than children without ADHD.

Neurofeedback training (NFT) aims at improving neurophysiological and neuropsychological functioning as well as general behavior. Consequently, NFT is also

expected to improve EF, self-control and school performance. Transferring acquired self-regulation skills from laboratory to real life is crucial to become effective to everyday situations. Transfer is believed to be facilitated via training using virtual reality (VR) environments. Consequently, NFT in VR is expected to yield greater effects than training in 2D.

Ninety children with ADHD (DSM-5) will take part in the study, 18 of whom participated until December 2016. After random assignment to one of three conditions, all participants receive 15 training sessions of either near-infrared spectroscopy (NIRS)-based NFT in VR, NIRS-based NFT in 2D (both of which strive to increase the amount of oxygenated hemoglobin in the prefrontal cortex), or electromyogram-based biofeedback training in VR. ADHD symptoms, self-control, EF, quality of life,

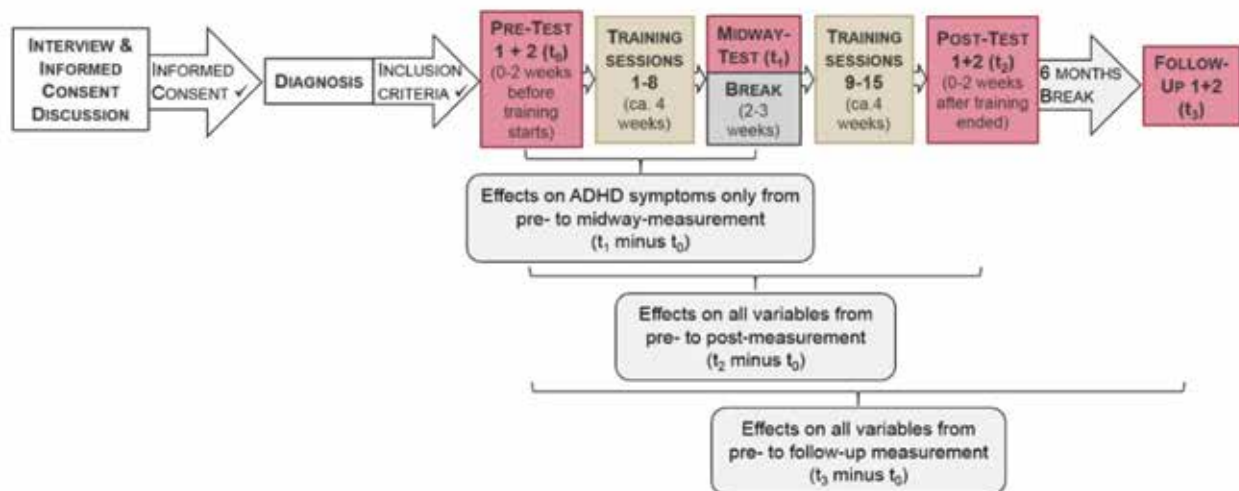

Figure 11. Flow chart presenting the course of the study.

school performance, cortical activity and motoric activity will be assessed before and after the intervention and in a six month follow-up (see figure 11 for an overview of the course of the study). The constructs are measured by parent, teacher and child reporting or tested objectively using accelerometers.

To our knowledge, this is the first study that investigates the efficacy of an NFT for children with ADHD in VR compared to a 2D environment. In addition to commonly assessed variables such as ADHD symptoms, EF, quality of life, and parental expectations regarding the intervention effects, this study will also investigate the effects on self-control, school performance, cortical activity, and motoric activity.



LEAD PhD candidates Justin Hudak and Friederike Blume apply neurofeedback training in a virtual reality (VR) environment.

CENTRAL PUBLICATIONS

Blume, F., Hudak, J., Dresler, T., Ehlis, A.-C., Kühnhausen, J., Renner, T. J., & Gawrilow, C. (2017). NIRS-based neurofeedback training in a virtual reality classroom for children with attention-deficit/hyperactivity disorder: study protocol for a randomized controlled trial. *Trials*, *18*, 1–16. doi:10.1186/s13063-016-1769-3

Hudak, J., Blume, F., Dresler, T., Renner, T. J., Gawrilow, C., Fallgatter, A. J., & Ehlis, A.-C. (2016). *Accelerated fNIRS-based neurofeedback modulates brain and behavior in highly-impulsive adults*. Manuscript submitted for publication.





INTERSECTION 3

CLINICAL AND PERSONALITY PSYCHOLOGY AND EDUCATION SCIENCES

MEMBERS

Katharina Allgaier
 Friederike Blume
 Vera Brenner
 Annette Conzelmann
 Thomas Dresler
 Ute Dürrwächter
 Ann-Christine Ehlig
 Andreas J. Fallgatter
 Caterina Gawrilow
 Richard Göllner
 Michael Paul Grosz
 Petra Haas (née Bugl)
 Martin Hautzinger
 Leona Hellwig
 Justin Hudak
 Aiste Jusyte
 Augustin Kelava
 Gabriel Kornwachs
 Jan Kühnhausen
 Sina Müller
 Benjamin Nagengast
 Sophia Antonia Press
 Tobias J. Renner
 Merle Reuter
 Sven Rieger
 Brent W. Roberts
 Johanna Schmid
 Marion Spengler
 Gordon Sudeck
 Jennifer Svaldi
 Ulrich Trautwein

The detection and minimization of factors that undermine academic success are among the most pressing challenges in education sciences. Potential risk factors may emerge from both socio-economic circumstances as well as from individual traits and dispositions, such as personality or mental health. How do personality differences affect academic performance? What are the causes of psychological problems in schools, such as attention deficit and hyperactivity disorder (ADHD), depression, or conspicuous behavior? Which mechanisms determine the relationship between academic performance and psychopathology and how can they be addressed? In intersection 3, a number of interdisciplinary research attempts are dedicated to answering these questions.

The methodological approach employed is naturally diverse, ranging from laboratory experimental studies to longitudinal investigations in field contexts. The combination of these approaches contributes to our understanding of individual differences in academic achievement as well as risk factors for mental health problems. These insights are highly relevant for the development, evaluation, and dissemination of school-based intervention programs.

One research focus of our intersection is **the role of individual differences in school**

contexts. Specifically, we are interested in how the learners' personality differences may contribute to performance, psychosocial adjustment, peer relationships, and even their perception of social cues in classroom settings. The results of this research not only help to identify and foster traits in learners which are associated with educational achievement, but they also provide valuable knowledge regarding risk factors.

Our **psychopathology** cluster is comprised of projects that address questions directly related to risk factors and causes of mental health problems in school-aged children. The main goal is to explain the mechanisms through which these disorders are maintained and exert their negative impact on academic performance and psychosocial adjustment. This research helps to better understand mental health problems, but also has the potential to aid the development of prevention and treatment strategies.

School-based prevention and intervention is another focus of the intersection. Here, we benefit from the expertise of our members from clinical psychology, education sciences, school psychology and neuroscience to develop innovative treatment methods and to investigate factors that may have an impact on the outcomes of prevention and intervention programs.

FINISHED DISSERTATIONS

Allgaier, K. (2015). *Honesty-humility at school: A Person x Situation approach to explain students' social behavior.* University of Tübingen.

Haas, P. (2017). *Physical activity in children and adults – Associations with affect and impact on executive functions.* University of Tübingen.

Müller, S. (2016). *Depressive symptoms in adolescence: Consequences, mechanisms, & school-based prevention efforts.* University of Tübingen.



SOCIAL CUES IN CLASSROOM SETTINGS

TEAM

Richard Göllner
Aiste Jusyte

A classroom not only constitutes a learning environment; it is also shaped by social interaction between learners and their teachers. The quality of these relationships is assumed to influence both teaching quality and learning outcomes. However, the mechanisms that govern this intricate classroom interplay are not well understood.

Previous studies from our as well as other laboratories suggest that the adequate perception and interpretation of nonverbal cues such as facial expressions is a crucial skill for all social interaction. Specific impairments have been documented in anxiety (Jusyte, Schneidt, & Schönenberg, 2015; Jusyte & Schönenberg, 2014), ADHD (Schönenberg, Schneidt, Wiedemann, & Jusyte, 2015), as well as in aggressive spectrum disorders (Jusyte, Mayer, Künzel, Hautzinger, & Schönenberg, 2015; Jusyte & Schönenberg, 2016; Schönenberg et al.,

2014). We know that this ability develops rapidly in children and is vital for normal social functioning. For instance, studies from our laboratory recently documented impairments in the ability to correctly recognize facial expressions in children with ADHD (Jusyte, Gulewitsch, & Schönenberg, 2016) and depression (Müller, Jusyte, Trzebiatowski, Hautzinger, & Schönenberg, 2016). Impaired social cognitive skills have been shown to have a negative impact not only on mental health but also on academic achievement. However, the processes underlying this association are barely understood and vastly understudied. To date, no study has experimentally investigated social cognition processes in educational settings. In this project, we build on our previous work and expertise in the field of social cognition in order to systematically investigate how learners perceive, interpret and react to teachers' nonverbal cues.

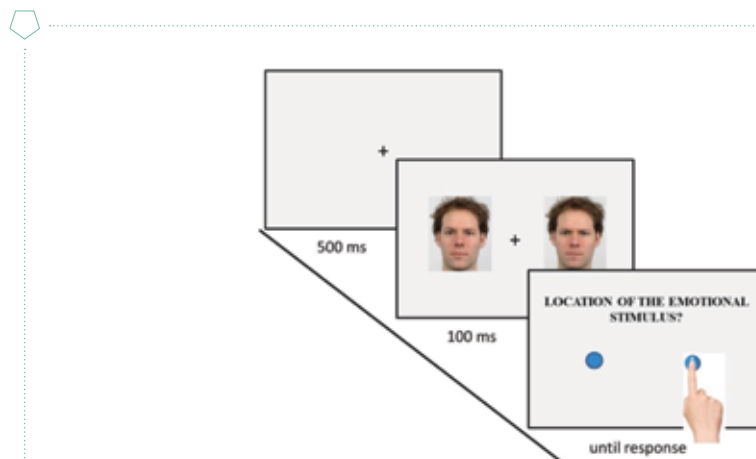

Figure 12. Illustration of the perceptual sensitivity task. 2AFC. Participants view a neutral and an emotional facial expression which differ with respect to intensity and are asked to determine the location of the emotional stimulus.

The current study is a first step to elucidate the mechanisms underlying the relationship between academic outcomes and social functioning by combining experimental and educational lines of research. Specifically, we are interested in how positive or negative performance feedback may affect subsequent processing of teachers' nonverbal signals (happy and angry facial expressions) in learners. The ability to perceive and interpret teachers' facial expressions will be assessed on several processing levels: visual awareness, perceptual sensitivity to affective expressions and processing biases in ambiguous stimuli using established paradigms from experimental psychology research. The paradigms are designed to investigate different processing levels, i.e., a) early visual processing using the continuous flash suppression paradigm (CFS), b) perceptual sensitivity for facial affect (see figure 12) and c) perceptual biases in ambiguous facial expressions (see figure 13).

COOPERATION PARTNERS

Timo Stein (University of Amsterdam, Netherlands)
Michael Schöenberg (University of Tübingen)

CENTRAL PUBLICATIONS

Jusyte, A., Mayer, S. V., Künzel, E., Hautzinger, M., & Schöenberg, M. (2015). Unemotional traits predict early processing deficit for fearful expressions in young violent offenders: An investigation using continuous flash suppression. *Psychological Medicine*, 45, 285–297. doi:10.1017/S0033291714001287

Jusyte, A., Schneidt, A., & Schöenberg, M. (2015). Temporal estimation of threatening stimuli in social anxiety disorder: Investigation of the effects of state anxiety and fearfulness. *Journal of Behavior Therapy and Experimental Psychiatry*, 47, 25–33. doi:10.1016/j.jbtep.2014.11.006

Jusyte, A., & Schöenberg, M. (2017). Impaired social cognition in violent offenders: perceptual deficit or cognitive bias? *European Archives of Psychiatry and Clinical Neuroscience*, 267, 257–266. doi:10.1007/s00406-016-0727-0

Müller, S., Jusyte, A., Trzebiatowski, S., Hautzinger, M., & Schöenberg, M. (2016). Processing of ambiguous facial affect in adolescents with depressive symptoms prior to and following social exclusion: The role of perceptual sensitivity and response bias. *Journal of Psychopathology and Behavioral Assessment*. Advance online publication. doi:10.1007/s10862-016-9582-6

Schöenberg, M., Schneidt, A., Wiedemann, E., & Jusyte, A. (2015). Processing of dynamic affective information in adults with ADHD. *Journal of Attention Disorders*. Advance online publication. doi:10.1177/1087054715577992

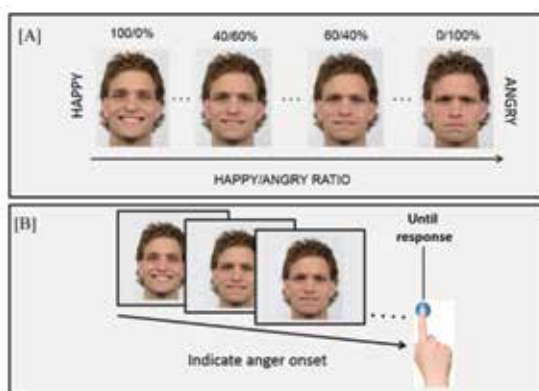

Figure 13. [A] Example of the stimulus material used for the perceptual bias task. [B] Illustration of a trial in the perceptual bias task. Participants view video clips of faces changing from happy to angry and indicate the onset of anger by pressing a button.



STUDENTS' EMOTIONAL WELL-BEING

TEAM

Katharina Allgaier
Richard Göllner
Sina Müller
Tobias J. Renner

National and international studies have identified a multitude of factors (e.g., socioeconomic background, parenting) that influence adolescents' development and learning. Conversely, the impact of students' emotional impairment has received less attention, even though clinical studies have shown that a substantial number of adolescents experience marked emotional and social problems. Specifically, with rates ranging in between 5 and 10 percent, internalizing problems (i.e., depression, anxiety) are highly prevalent and are stable conditions that pose a significant risk for relapse and recurrence (Lewinsohn, Clarke, Seeley, & Rohde, 1994).

In our previous project, we examined the academic (reading and math achievement) and social (self-rated acceptance, peer-rated acceptance, teacher-rated acceptance, relationship with parents) development of adolescents with internalizing problems and those without. The sample consisted of 1,062 German students who were assessed at four points in time over a 3-year period from grades 5 to 8. Growth curve analyses revealed significant differences between students with versus without internalizing problems at fifth grade and over time. At fifth grade, students with internalizing symptoms had significantly lower scores in all examined functioning domains. Differences in change over time

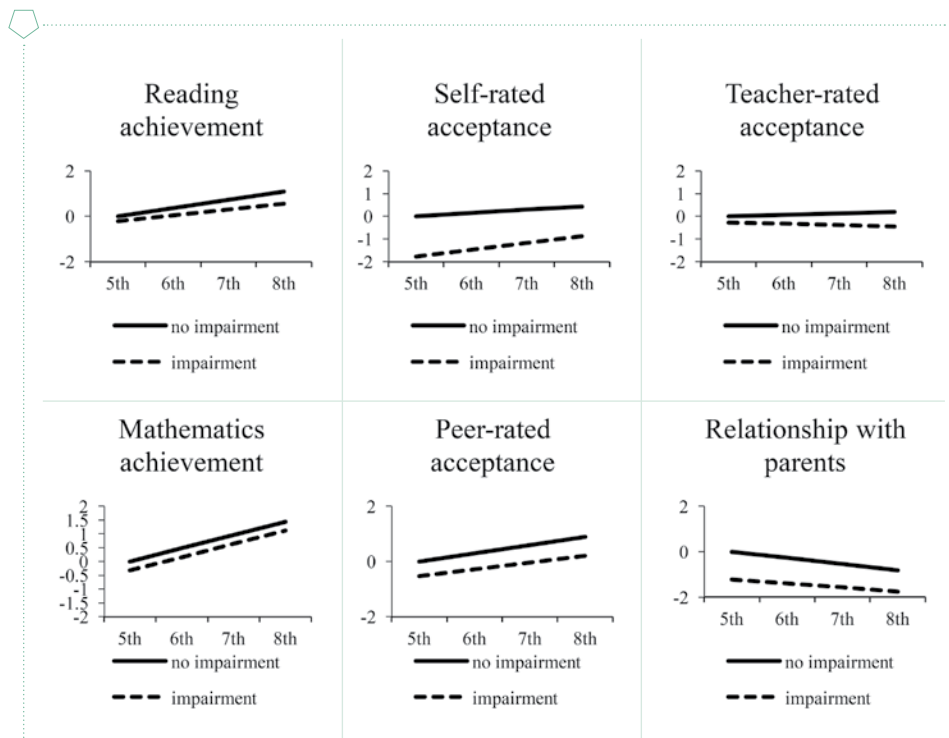

Figure 14. Predicted average trajectories for the investigated outcomes (controlled for the covariates). Significant trajectory differences are depicted in the first row, nonsignificant ones in the bottom row.

between students with versus without internalizing problems emerged for reading achievement (positive growth for both groups but less positive growth for students with internalizing problems), self-rated acceptance (positive growth for both groups but more positive growth for students with internalizing problems), and teacher-rated acceptance (positive growth for those without internalizing problems and negative growth for those with internalizing problems).

Building on these results and our shared interest in adolescent development, our interdisciplinary research team developed a grant proposal that was successful in a

competitive call for research projects. The aim of this project is to investigate the impact of emotional impairment in early adolescence on the transition into tertiary education and work life. Specifically, the current project aims at (1) investigating differences in academic trajectories and academic success between young adults who had previously suffered from internalizing problems vs. those who had not suffered from them, (2) identifying the impact of mediating social and academic factors, and (3) investigating the impact of socioeconomic background on the transition experiences of young adults with and without previous internalizing problems. The project uses data from the

TRAIN study (Jonkmann, Rose, & Trautwein, 2013), a longitudinal study, designed to analyze non-academic track students' social and academic development from grades 5 to 8. The total sample consists of 3,880 students, 47 percent of whom are female. The first phase of the TRAIN study was carried out annually from 2008 until 2012. In the current phase of the project (fall 2016), the now young adults are assessed again in order to gather detailed information about their transition into tertiary education and their current occupational situation.

SUPPORTED BY



CENTRAL PUBLICATIONS

Müller, S., Göllner, R., Lösch, T., Jusyte, A., & Trautwein, U. (2016). *Adolescents' internalizing problems and their impact on academic and social development*. Manuscript submitted for publication.

Göllner, R. (2014). Psychische Störungen und ihre Bedeutung für die Entstehung sozialer Ungleichheit: Ein Überblick [Mental disorders and their importance for the emergence of social inequality: An overview]. *Zeitschrift für Erziehungswissenschaft*, 17(2), 281–297. doi:10.1007/s11618-013-0472-3

THIRD-PARTY FUNDS ORIGINATING FROM THIS PROJECT

Müller, S., Göllner, R., Allgaier, K., Renner, T.: Student's emotional well-being and its impact on educational processes during the school-work transition. Netzwerk Bildungsforschung der Baden-Württemberg Stiftung, 50.000 €, 04/2017–06/2018.



PROMOTING SELF-REGULATION IN CHILDREN

TEAM

Caterina Gawrilow
 Petra Haas (née Bugl)
 Augustin Kelava
 Johanna Schmid
 Gorden Sudeck

Self-regulation and executive functions, such as the ability to inhibit prepotent reactions, are critical for successful transition from kindergarten to school and predict academic achievement (e.g., Blair & Razza, 2007). But how can we efficiently improve children’s self-regulation and executive functions in their daily lives? A promising approach is the implementation of physical activity interventions. Such interventions are low cost, easily accessible, and yield positive effects on both mental and physical health. To date, research in adults impressively demonstrates the effects of physical activity to improve executive functions (Barenberg, Berse, & Dutke, 2011). However, in order to introduce evidence-oriented physical activity interventions on a large scale in kindergartens and schools, standardized studies that identify relevant moderators in samples of children are necessary.

A total of 103 children participated in this study until September 2016. The children were randomly assigned to one of two conditions (figure 15).

In the intervention condition, the child performed various coordinative physical activities (figure 16); in the control condition, the child listened to a story. Both conditions lasted 18 minutes, were embedded in the same age-appropriate fairytale, and took place in a standardized single child-experimenter setting. By doing so, we avoided confounding social effects (e.g., due to group settings). First results indicate that children’s heart rate was significantly increased in the intervention condition compared to the control condition (figure 17).

To evaluate the effects of both conditions, children’s executive function performance was assessed directly after the intervention

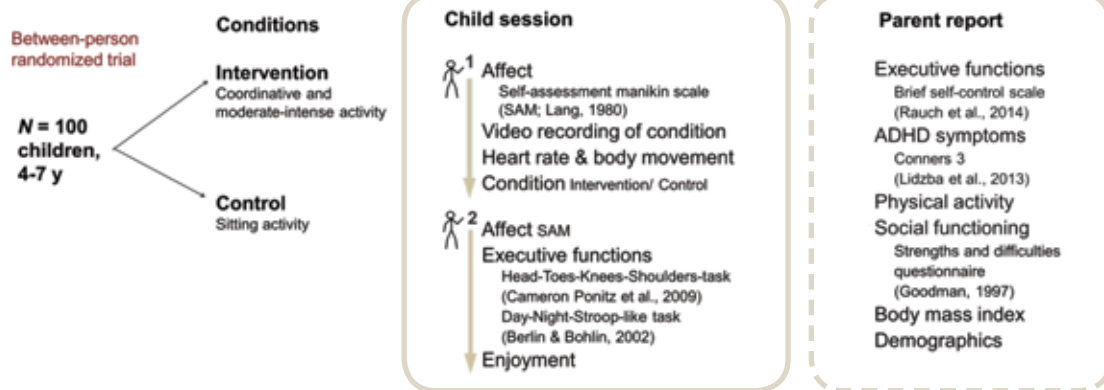

Figure 15. Study design.

with both behavioral as well as computerized paradigms measuring response inhibition, for example by asking the child to say 'girl' when seeing a picture of a boy. Additionally, parents filled out questionnaires in order to take into account children's background characteristics (e.g., body mass index, habitual sport activities). Our results will reveal new insights into the effectiveness of physical activity for improving executive functions. Although physical activity is widely known to enhance learning, large scale implementation in kindergartens and schools should not take place before having established a theory-driven, evidence-oriented intervention. Based on our findings, further field studies may provide results for deriving practical recommendations for early education.

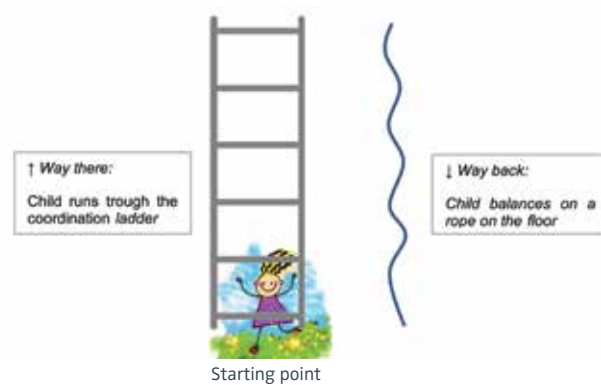

Figure 16. Exemplary exercise of physical activity intervention.

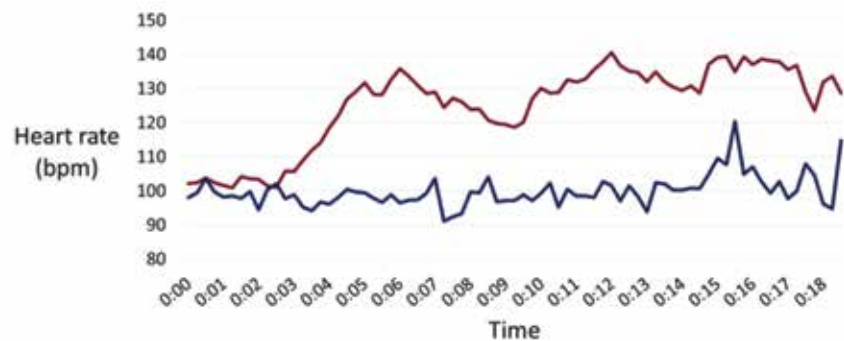

Figure 17. Preliminary results: Time course of mean heart rate in the intervention condition (red line, $n = 30$) and in the control condition (blue line, $n = 31$).

COOPERATION PARTNERS

Mirko Schmidt, Fabienne Egger (University of Bern, Switzerland)

CENTRAL PUBLICATIONS

Haas, P., Schmid, J., Stadler, G., Reuter, M., & Gawrilow, C. (2016). Zooming into daily life: Within-person associations between physical activity and affect in young adults. *Psychology & Health, 32*, 588–604. Advance online publication. doi:10.1080/08870446.2017.1291943

Bugl, P., Schmid, J., & Gawrilow, C. (2015). Ambulantes Assessment in der Schule: Den schulischen Alltag erfahrbar machen [Ambulatory assessment in school: Discovering daily school life]. *Lernen und Lernstörungen, 4*, 261–268. doi: 10.1024/2235-0977/a000115





INTERSECTION 4

LANGUAGE AND LEARNING

MEMBERS

Daniela Ahlberg
 Harald Baayen
 Karin Berendes
 Katharina Braungart
 Doreen Bryant
 Xiaobin Chen
 Maria Chinkina
 Ulrike Cress
 Gabriella Daroczy
 Benjamin Fauth
 Peter Gerjets
 Evelin Herbein
 Barbara Kaup
 Olaf Kramer
 Carmen Lipphardt
 Detmar Meurers
 Benjamin Nagengast
 Hans-Christoph Nürk
 Patrick Rebuschat
 Simón Ruiz Hernández
 Fabian Ruth
 Katharina Scheiter
 Benjamin Siegmund
 Maike Tibus
 Ulrich Trautwein
 Sowmya Vajjala
 Sophie Vogel (née Rummel)
 Magdalena Wolska

Language is central to learning and critical for academic success. On the one hand, lack of exposure to and understanding of complex, academic language hinders language learning and acquisition of knowledge. On the other hand, limited language production capabilities inhibit demonstration of knowledge in communicative situations and in the course of assessments. Thus, language is necessarily central to any education-oriented research and in LEAD effectively links all of the graduate school's subareas.

Thematically, our research can be categorized into three major strands: linguistic complexity in education, explicit and implicit instruction in language learning, and language use in context.

Research on **linguistic complexity in education** includes analysis of items in tests and surveys and of textbooks. We developed computational methods for analyzing a wide range of linguistic complexity features for German and English and are using these to explore differences between schoolbooks for different age groups or school types. LEAD research also investigates the impact of linguistic complexity on student responses to survey items in educational large-scale assessments, and it displays the relevance

of linguistic complexity for children solving mathematical word problems.

In the second strand, LEAD targets the balance **between implicit and explicit instruction of form and of meaning in language learning**. Research explores automatic input enrichment and input enhancement in web-based settings while experiments study the role of meaning in acquiring grammar or inductive and deductive strategies in teaching Latin. An intervention study employs scaffolding techniques to build academic language at the transition from primary to secondary school.

Thirdly, a rich strand of LEAD research focuses on **language use in context**. It integrates foundational research investigating the role of embodiment in language learning as well as drama-grammatical interventions for German second-language learners in primary school. Considering rhetoric as the art of discourse, LEAD research studies the effectiveness of interventions and training programs targeting speech clarity and vividness of presentations in primary and secondary school.

FINISHED DISSERTATIONS

Ahlberg, D. (2016). *Embodiment in first and second language acquisition*. University of Tübingen.

Herbein, E. (2017). *Public speaking training as an enrichment program for elementary school children: Conceptualization, evaluation, and implementation*. University of Tübingen.

Vajjala, S. (2015). *Analyzing text complexity and text simplification: Connecting linguistics, processing and educational applications*. University of Tübingen.



LINGUISTIC COMPLEXITY OF SCHOOLBOOK TEXTS

TEAM

Karin Berendes
Doreen Bryant
Detmar Meurers
Sowmya Vajjala



READING DEMANDS in Secondary School

Reading is a core competence for acquiring knowledge and the development of reading skills is closely linked to the learning opportunities provided in the classroom. In addition to the structural and procedural characteristics of teaching and the time spent on reading, the nature of the reading material plays a central role in this process. The aim of the Reading Demands project was to analyze and compare the nature of the reading material in terms of the linguistic complexity of textbooks for different school tracks and grades.

After systematically collecting all geography textbooks approved in the state of Baden-Württemberg for the different school tracks and grades, we examined the linguistic characteristics of the texts they contained using computational linguistic methods. We focused on expository texts, which represent a near majority (49%) of the texts in the textbooks. A total of 5,973

texts from 35 textbooks by four publishers for grades 5 to 10 were examined.

A wide spectrum of lexical, morphological and syntactic characteristics was analyzed and compared between school tracks and grades. The analysis revealed that in general the texts do not appear to be systematically written in a way that adapts the linguistic complexity of the texts to the language abilities of the students in the different grades and school tracks. The results therefore provide an opportunity for publishers to more explicitly consider the nature of the linguistic encoding of the information in the textbooks, which arguably should be in line with the curriculum content. To support this process, we are considering the development of a web-based tool to support textbook editors in analyzing the relevant aspects of linguistic complexity.

CENTRAL PUBLICATIONS

Berendes, K., Vajjala, S., Meurers, D., Bryant, D., Wagner, W., Chinkina, M. & Trautwein, U. (2016). *Reading Demands in Secondary School: Does the Linguistic Complexity of Textbooks Increase with Higher Grade Level and Higher Academic Orientation of the School Track?* Manuscript submitted for publication.

Bryant, D., Berendes, K., Meurers, D. & Weiß, Z. (in press). Schulbuchtexte der Sekundarstufe auf dem linguistischen Prüfstand: Analyse der bildungssprachlichen Komplexität in Abhängigkeit von Schultyp und Jahrgangsstufe. [Secondary school text books on the linguistic test bed: Analysis of the linguistic complexity depending on the type of school and grade]. In M. Hennig (Hrsg.), *Linguistische Komplexität – ein Phantom?* Tübingen: Stauffenburg Verlag.



The project team including the LEAD members Doreen Bryant, Detmar Meurers, Karin Berendes, and Sowmya Vajjala.



HOW CAN FOREIGN GRAMMAR LEARNING BE FACILITATED?

TEAM

Katharina Braungart
Barbara Kaup
Detmar Meurers

In a globalizing world, learning foreign languages is more crucial than ever. The new education curriculum for grammar schools in Baden-Württemberg (2016) elaborates on the significance of language learning by citing Jürgen Baumert (2002), who describes competence in foreign languages as a fundamental “cultural instrument” (Kulturwerkzeug). The learning of a new grammatical system is typically one of the most demanding subtasks. With three studies we tried to shed light on the question of how the acquisition of a foreign grammar can be facilitated.

An important challenge in language teaching is how to integrate different aspects of the language, especially form and meaning aspects. Should grammar be taught independently of meaning, or does knowledge about the meaning of a sentence facilitate the acquisition of the new grammar? In two consecutive experiments, we presented 160 participants with Latin sentences and instructed them to identify the

underlying rules. Participants were either given the meaning of the sentences (experimental group) or not (control group). We implemented different ways of providing the experimental group with the meaning of the sentences. In experiment 1, participants received photographs that depicted the meaning of the sentences, whereas in experiment 2 they received a quasi-translation in a propositional-like format specifying the thematic roles in the sentences (see figure 18). The aim of experiment 2 was to rule out possible alternative explanations, such as a multimedia effect.

In the post-test of both experiments, participants were asked to distinguish grammatically correct from grammatically incorrect sentences to assess their acquired grammatical skills. The results were very clear: Participants in the experimental group, who acquired grammar with meaning, clearly outperformed participants in the control group, who acquired grammar without meaning. This was the case independent of whether meaning was

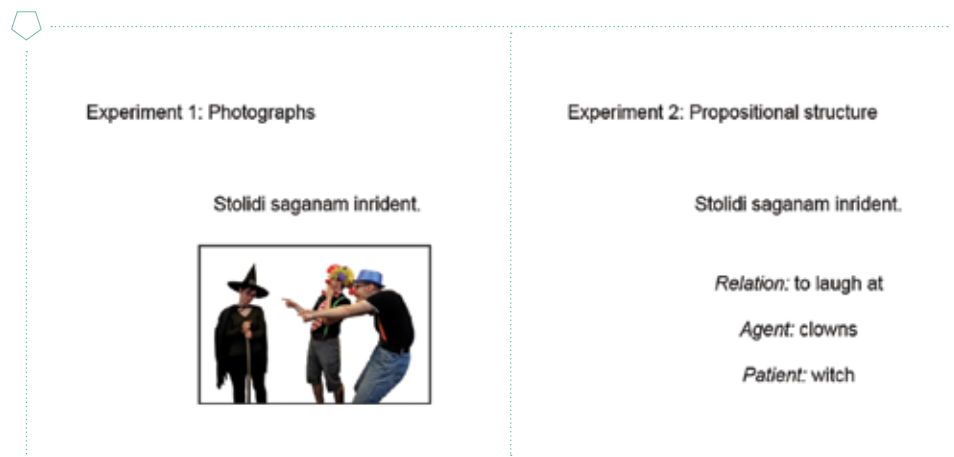

Figure 18. Different formats of presenting sentences and their meaning.

presented in form of a photograph or in form of a quasi-translation.

Another crucial field in language teaching is instructional design. In our second study, we focused on the question of whether learners need explicit information about the grammatical structures in order to acquire grammar rules. We used the so-called cross situational learning paradigm which imitates a natural language learning setting in the lab. A total of 90 participants were presented with Latin sentences and at the same time two pictures, from which they had to pick the one that was described by the sentence. We tested three groups of participants who either received explicit, partially explicit or no information about the grammatical structures. This method enabled us to gain insight not only into the overall learning performance, but also into the dynamics of the learning process. A total of 90 participants were tested in three groups with different instructions. The study was carried out in collaboration with Patrick Rebuschat and Padraic

Monaghan (Lancaster, UK). Data analysis is still ongoing.

The third study of the project attempts to shed light on a memory-related issue of language learning. From research concerned with the so-called testing effect (Carrier & Pashler, 1992), it is well known that (self-)testing during the learning of new contents can improve the memory performance as well as the retention of the newly acquired knowledge. We are aiming at investigating whether this also holds true for grammar learning. The study will be carried out as an online experiment and is currently in preparation.

COOPERATION PARTNERS

Patrick Rebuschat, Padraic Monaghan (Lancaster University, UK)

THIRD-PARTY FUNDS ORIGINATING FROM THIS PROJECT

Braungart, K., Kaup, B., Öttl, B.: Co-funding of the international PhD workshop "Studying Language Learning: From the Laboratory to the Classroom", Tübingen. Future Concept of the Excellence Initiative at the University of Tübingen, 6.754 €, December 2015.



DEVELOPMENT AND TRAINING OF SCIENTIFIC PRESENTATION SKILLS

TEAM

Benjamin Fauth
Olaf Kramer
Carmen Lipphardt
Fabian Ruth
Katharina Scheiter
Ulrich Trautwein

Presentations are a crucial part of today's school system. Student presentations are not only used as an examination method or performance test, they also aim at the development of competences and enhance peer-to-peer-learning through the dissemination of knowledge in a presentation. When focusing on the question of how students can convey knowledge in an efficient way, rhetoric comes into play, stylistic features of language and media use, as well as the performance of the presenters. We have conducted two studies to evaluate how students' rhetorical competence can be fostered through presentation trainings and also to promote empirical research in the field of rhetoric, which, in the past,

was mostly occupied with hermeneutic or analytical approaches.

One study focuses on the evaluation of a presentation training program in the nationwide scientific presentation contest "Jugend präsentiert" ("Youth presents"). The intervention took place in the form of a "presentation academy", a two-day presentation training developed by the Presentation Research Center at the University of Tübingen. Around 100 students (age 12-19) participated in this training, which included modules on the rhetorical analysis of the situation, instrumental-operative competence, and performance aspects. One key aspect to evaluate the effectiveness of this

SUPPORTED BY

Klaus Tschira Stiftung
gemeinnützige GmbH



Self-reports

Presentation competence (t_2)

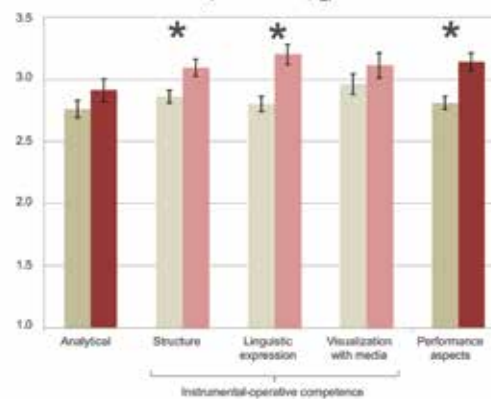

| | Analytical | Structure | Linguistic expression | Visualization with media | Performance aspects |
|-----|--------------|-------------|-----------------------|--------------------------|---------------------|
| d | 0.28 | 0.45 | 0.83 | 0.25 | 0.84 |
| CI | -0.14 - 0.70 | 0.03 - 0.86 | 0.4 - 1.25 | -0.18 - 0.67 | 0.41 - 1.26 |

Note: d = Cohen's d ; CI = 95% confidence interval; * $p < .05$

Speech anxiety (t_2)

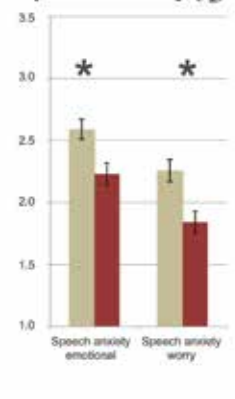

| | Speech anxiety emotional | Speech anxiety worry |
|-----|--------------------------|----------------------|
| d | -0.63 | -0.63 |
| CI | -1.04 - -0.20 | -1.05 - -0.21 |

Figure 19. Self-reports from the Presentation Academy regarding the self-assessment of presentation competence and speech anxiety show a higher value of presentation competence and a lower level of speech anxiety with the experimental group.

presentation training was to develop a video assessment instrument for presentation competence, based on the presentations held and taped at different stages during the contest. For this, a group of university students were trained to rate the presentations filmed before, during, and after the intervention. Additionally, students filled out questionnaires and self-reports during all stages of the presentation contest. While the ratings are still being evaluated, self-reports and questionnaires show an improvement in the self-perception of presentation competence as well as a decrease in speech anxiety.

The evaluation of the filmed presentations

shows that the assessment instrument is functional, and the results of the evaluation of the student presentations will follow shortly.

The second study is concerned with the process of knowledge dissemination in peer-to-peer learning and the role of the rhetorical techniques of clarity and vividness, which can be used verbally as well as visually. The study poses two research questions, firstly regarding the teenage students' general understanding of rhetorical techniques and secondly the effects of training the techniques of clarity and vividness on the presenter. The study targets advanced level students in the 11th and 12th grade, who are asked

to hold a presentation after they have received either placebo training or training specifically designed to foster clarity and vividness. Additionally, the students filled out questionnaires. In July 2016, a total of 90 students from 3 schools participated; the evaluation of the data is currently ongoing.

With both studies, the Presentation Research Center, which is funded by the Klaus Tschira Stiftung (KTS), Heidelberg, and located at the Seminar für Allgemeine Rhetorik, strives to advance the research on presentations as well as foster the presentation competence of students, especially in STEM education.

CENTRAL PUBLICATIONS

Kramer, O., Malaka R. (Eds.). (2012). *Multiplikatorenhandbuch Jugend präsentiert*. [Multipliers handbook Youth Presents]. Heidelberg.

Kramer, O. (Ed.). (2014). *Jugend präsentiert kompakt. Eine Einführung für Lehrkräfte der Sekundarstufe I und II*. [Youth presents compact. An introduction for teachers at secondary level I and II]. Heidelberg.

Kramer, O. (Ed.). (forthcoming). *Media of Evidence/Evidence of Media*. Carbondale, IL.

Zettler, I., Thoemmes, F., Hasselhorn, M., & Trautwein, U. (2014). Aktuelle Lösungsansätze für methodische Herausforderungen in der Talent- und Begabungsforschung [Current approaches for methodological challenges in talent research]. In M. Stamm (Ed.), *Handbuch Talententwicklung: Theorien, Methoden und Praxis in der Psychologie und Pädagogik* (pp. 205–215). Bern: Hans Huber.

THIRD-PARTY FUNDS ORIGINATING FROM THIS PROJECT

Kramer, O.: Jugend präsentiert Forschungsstelle [Youth Presents research center]. Klaus Tschira Foundation, 2.500.000 €, 07/2011–08/2021.





INTERSECTION 5

EDUCATION, LIFE COURSE DEVELOPMENT, AND SOCIAL DISPARITIES

MEMBERS

Cansu Atlay
 Omar Adam Ayaita
 Jörg Baten
 Dominik Becker
 Martin Biewen
 Taiga Brahm
 Isabelle Fischer
 Andreas Hartung
 Steffen Hillmert
 Anne-Kathrin Knauf
 Karoline Mikus
 Benjamin Nagengast
 Lorena Ortega
 Kerstin Pull
 Ina Elisabeth Rüber
 Kai Sassenberg
 Bernhard Schmidt-Hertha
 Pia Schober
 Josef Schrader
 Marion Spengler
 Madalina Tapalaga
 Ansgar Thiel
 Nicole Tieben
 Ulrich Trautwein
 Nele Usslepp
 Leen Vandecasteele
 Katarina Weßling
 Philip Yang

In this intersection, we examine how education and learning are embedded in social contexts. Research topics are not limited to particular stages of the educational system, but follow the entire life of an individual from early childhood to continuing education. Closely related, the intersection also examines returns on education and training in later stages of life, such as labor market outcomes, social integration and satisfaction.

The interdisciplinary approach consists of researchers from the fields of economics, sociology, education sciences and psychology, which allows the integration of state-of-the-art theoretical and empirical models in order to address topical questions concerning educational opportunities on micro- and macro-levels of society. The main methodological approach is the secondary data analysis of large scale longitudinal surveys, complemented with own data collections using quantitative methods. In order to address life-course related research questions, prospective panel data as well as retrospective life-course data are used. Furthermore, the spectrum of methods includes longitudinal and multilevel models to thereby examine, for example, multiple transitions or context conditions. Where possible, data from standardized achievement tests are included to better control for selection effects.

Regarding **inequality and mobility in educational trajectories**, we examine individual and context factors which explain individual educational aspirations, decisions

and pathways. Research dealing with educational inequality consistently reveals that family background is highly associated with children's school performance, educational aspirations and decisions. This research focuses on how context conditions within and outside the family, such as schools and neighborhoods, influence children's development.

We also examine **pathways into, through and out of higher education**. This research scrutinizes questions of progress and persistence in higher education and strives to identify "risk-factors" that are related to delayed graduation and non-completion. In particular, the diversity of pathways to higher education raises the question of how detours to higher education translate into specific transition patterns through and out of higher education. This research therefore aims to acknowledge the embeddedness of higher education in individual vita and the resulting resources and limitations.

The research field **Educational Transitions and Economic Outcomes** focuses on the sequential nature of educational trajectories and on returns of education. The highly tracked educational system in Germany channels students into different tracks very early in life, which may result in path-dependencies and inequality. This area therefore aims to shed light on how the diverse non-linear pathways through the German educational system translate into revisions of early educational decisions and how this serves to reduce or enhance social inequality.

FINISHED DISSERTATIONS

Weßling, K. (2016). *The influence of socio-spatial contexts on transitions from school to vocational and academic training in Germany.* University of Tübingen.



ENVIRONMENTS AND EDUCATIONAL SUCCESS

TEAM

Andreas Hartung
Steffen Hillmert
Katarina Weißling

Individual educational success can be traced to two theoretical mechanisms: On the one hand, external structural and institutional conditions are responsible for providing objective educational opportunities. On the other hand, the individual's educational intention, motivation and goals are key determinants of educational success. Previous research has consistently shown that beyond institutional settings, individual educational aspirations appear to be mainly influenced by parents, peers, and neighborhood contexts.

Empirical evidence shows that parents and children of higher social classes not only have higher initial aspirations, but also that their aspirations are more stable over time and less adaptable. Peers and acquaintances also have a significant effect on the education and career plans of young people. These effects are strongly related to the importance of the

socio-economic composition of the school environment.

This research project deals with the effect that academically educated people in the residential environment have on an individual's educational aspirations. A higher share of academics in the neighborhood is expected to increase educational aspirations through more interaction with highly educated persons. These contacts can function as "role models" as they exemplify a specific life concept in which education plays a crucial role for economic welfare, social status and social acceptance. Social norms can additionally set expectations concerning educational performance and attitudes towards educational attainment levels. Small-scale geo-referenced data enables us to aggregate contexts flexibly within a radius around a particular location. We expect to observe strongest effects within a radius of up to a few kilometers, i.e., a

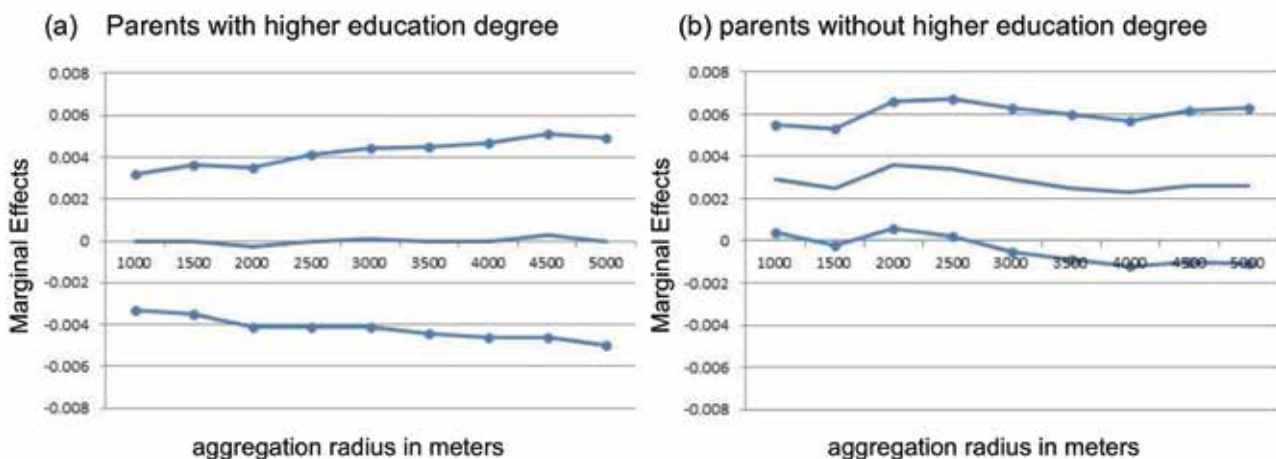

Figure 20. Average marginal effects (AME) of proportion of academics on aspirations for higher education, data: GSOEP, microm consumer marketing.

radius in which everyday interaction is assumed to take place.

We find that the share of academics in the residential environment does in fact positively support the aspirations of young people to attend higher education. However, this effect is only observed for young people whose parents have no higher education. We also can confirm our expectation that this effect is limited to an interaction radius of up to 2,500 meters.



Figure 21. Flexible operationalization of living environments, exemplified for three cases with two different radii.

SUPPORTED BY

DFG Deutsche
Forschungsgemeinschaft

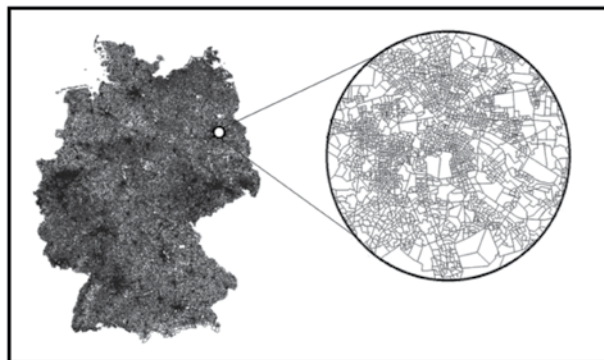

Figure 22. Micromarket cells example for the city of Berlin, data: microm consumer marketing.

CENTRAL PUBLICATIONS

Hartung, A. (2016). *Academic composition of the residential environment and educational aspirations to attend higher education*. Working Paper. University of Tübingen.



PATHWAYS INTO, THROUGH AND OUT OF HIGHER EDUCATION

TEAM

Martin Biewen
Annika Grieb
Anne-Kathrin Knauf
Benjamin Nagengast
Nicole Tieben
Ulrich Trautwein
Nele Usslepp

Every year a growing percentage of each birth cohort enters higher education. At the same time, pathways into higher education have become more flexible and diverse over the past decades. For both practical and theoretical purposes, more knowledge is needed about pathways into and through the system of higher education. In bringing together sociological, educational, and psychological perspectives, LEAD strives to contribute to the existing knowledge in the field.

One example of work of this area is the incorporation of life-course perspectives into higher education research. We perceive higher education as part of an individual qualification strategy that can be pursued during and after periods of vocational training and labor market participation. Pre-tertiary education in Germany places a strong emphasis on vocational training. On the one hand, students can pursue post-secondary vocational training in order to obtain formal qualifications for

entering the skilled labor market; on the other hand, upper secondary education does not only consist of general upper secondary institutions, but also of upper secondary institutions with a vocational specialization. Hence, access to higher education can be obtained with a variety of pathways, including vocational training and specialized upper secondary schools. This raises the question of whether these vocational routes “divert” students away from higher education or facilitate access to higher education, and whether they contribute to social disparities in educational achievement. Furthermore, we are interested in knowing whether vocational knowledge and skills obtained in pre-tertiary education are helpful during higher education or are rather associated with higher rates of non-completion. We assume that pre-tertiary vocational specialization is indicative of a clear occupational concept and expectations of students and that for this reason the choices in higher education are more stable. Moreover, vocational knowledge



LEAD faculty member Martin Biewen and Mirte Scholten from Mannheim University discussing their research.

may be beneficial in higher education since students profit from their skills. However, formal vocational qualifications open attractive alternatives outside higher education, which may lead to higher drop out probability.

Our empirical findings suggest that formal vocational qualification is a "safety net" in case of dropout from higher education: Whereas dropouts without these qualifications often have to enter vocational training programs in order to enter the skilled labor market, dropouts with pre-tertiary vocational qualifications normally have little difficulty to enter the skilled labor market.

SUPPORTED BY



COOPERATION PARTNERS

Mirte Scholten (MZES, Mannheim University)
 Uta Liebeskind (DZHW, Hannover University)
 Elisabeth Hovdhaugen (NIFU, Oslo)

CENTRAL PUBLICATIONS

Scholten, M., & Tieben, N. (revise and resubmit). Vocational qualification as safety-net? Education-to-work transitions of higher-education dropouts in Germany.

Scholten, M., & Tieben, N. (2016). Labour market outcomes of higher-education dropouts in Germany: How formal vocational qualifications shape transitions and occupational status. *Mannheimer Zentrum für Europäische Sozialforschung: Arbeitspapiere 168*.

Tieben, N. (2016). Verbleib und Berufsstatus von Studienabbrecherinnen und Studienabbrechern mit und ohne vorherige Berufsausbildung – Ergebnisse aus dem Nationalen Bildungspanel (NEPS) [Whereabouts and professional status of drop-out students with and without prior vocational training – Results from the National Educational Panel Study (NEPS)]. In *Datenreport zum Berufsbildungsbericht 2016. Informationen und Analysen zur Entwicklung der beruflichen Bildung*. Bonn: Bundesinstitut für Berufsbildung.

Tieben, N. (2016). *LEAD-Expertise – Studienverlauf, Verbleib und Berufsstatus von Studienabbrechern* [LEAD expertise – Course of studies, whereabouts and professional status of drop-out students]. Ergänzende Informationen zum Datenreport zum Berufsbildungsbericht.

Kramer, J., Zettler, I., Thoemmes, F., Nagy, G., Lütke, O., & Trautwein, U. (2012). Stellen Hochschultypen differenzielle Entwicklungsmilieus dar? Eine Propensity-Score-Analyse zu den Effekten des Hochschulbesuchs [Do university types represent differential developmental environments? A propensity score analysis on the effects of university attendance]. *Zeitschrift für Erziehungswissenschaft, 15*, 847-874. doi:10.1007/s11618-012-0280-1

THIRD-PARTY FUNDS ORIGINATING FROM THIS PROJECT

Trautwein, U., Tieben, N., Nagengast, B. & Kramer, J.: Vom Beruflichen Gymnasium auf die Hochschule: Sagt eine „passende“ Studienwahl den Studienerfolg vorher? [From vocational high school to university: Does a "suitable" choice of studies predict the success of the studies?]. *Netzwerk Bildungsforschung der Baden-Württemberg Stiftung*, 37.000 €, 10/2016–12/2017.

Tieben, N.: STUBA: Studienverläufe Studierender mit vor-tertiärer beruflicher Ausbildung [The course of studies of students with pre-tertiary vocational training]. Federal Ministry of Education and Research (BMBF), 172.500 €, 03/2017–02/2020.



EDUCATIONAL TRANSITIONS AND ECONOMIC OUTCOMES

TEAM

Martin Biewen
Madalina Tapalaga

Educational qualifications are a major determinant of labor market success and therefore an important source of economic and social inequalities. Most education systems have a complex structure with multiple stages and differentiated tracks. The sequential nature of educational decisions makes it necessary to consider all transitions. Focusing only on achieved educational levels or individual transitions ignores how a given level is achieved and how background factors (such as parental education) influence previous decisions (Cameron and Heckman, 2001).

This project uses newly available data from the National Educational Panel Study (NEPS, starting cohort 6) to study educational trajectories in Germany.

From an international perspective, the German system is of particular interest for at least two reasons: First, it provides highly institutionalized branches of vocational and academic training, which is deemed to be a potential model for other countries – especially for those with high youth unemployment rates. Another distinguishing feature of the German system is that it channels individuals into different tracks at an extremely early age (typically 10 years). Indeed, the German system is widely considered ‘the starkest example of early tracking’ (Brunello et al., 2012).

What is less known, however, is that, despite the pronounced feature of early tracking, the system provides the possibility

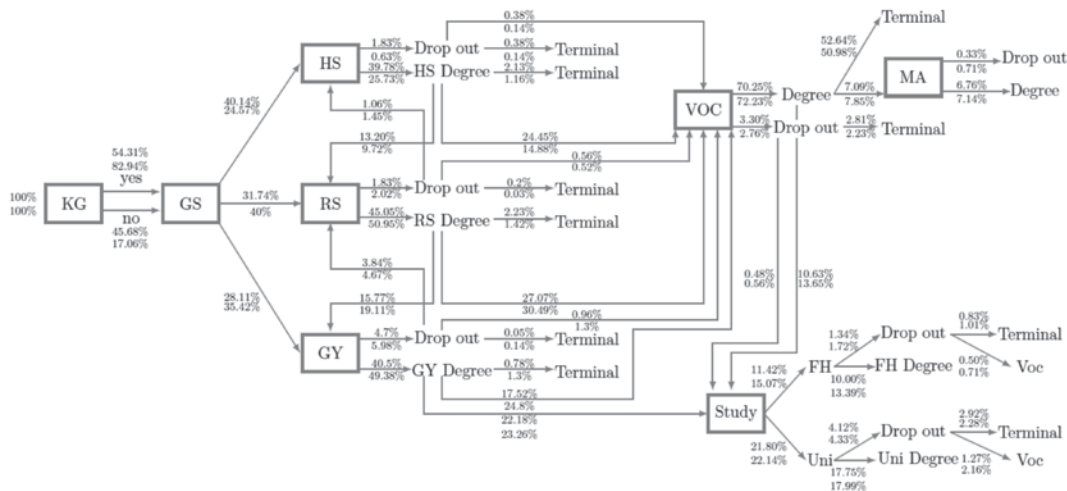

Figure 23. German education system. Percentages of population going through different branches (upper numbers: birth cohort 1950–1964, lower numbers: birth cohort 1965–1979). Source: NEPS, SC6.

to switch tracks at many points and to pursue indirect routes to reach a particular educational goal. Our approach to studying complete sequences of educational decisions allows us to investigate in detail such indirect routes through the system. For example, individuals may upgrade to a higher track of secondary schooling after having completed a lower track, or they may decide to take up studies at a university after first opting for a vocational degree. We also study educational transitions that have rarely been studied before, such as the decision to obtain a degree as a master craftsman after successful completion of a vocational degree or the decision to study at a university as opposed to a more practically oriented university of applied sciences (FH).

Our results show that a surprisingly high number of individuals takes indirect routes through the system, i.e., revises earlier track decisions at later stages. However, we also show that such indirect routes are as socially selective as the standard routes through the system and thus do not serve to reduce social and economic inequalities. It appears that the option to revise earlier decisions is not mainly used by those whose poor background may have held them back at earlier decisions, but rather by those from higher backgrounds who seize the 'second chance' to obtain the status achieved by their parents. We show that parental background variables not only influence early track choices, but also very late ones such as the decision to study at a university rather than a university

of applied science. A cohort comparison reveals a generally stable pattern of social selectivity across two birth cohorts (1950-1964 vs. 1965-1979). This generalizes earlier findings that educational expansion did not successfully reduce social selectivity.

In the second part of the project, we link educational transitions to economic outcomes such as the wage earned and the occupational position reached. In this way, we are able to measure the 'returns' of particular educational transitions. Moreover, we are able to investigate whether individuals make educational choices for which the individual returns are particularly high.

CENTRAL PUBLICATIONS

Biewen, M., & Tapalaga, M. (2017). Life-cycle educational choices in a system with early tracking and 'second chance' options. *Economics of Education Review*, 56, 80–94. doi:10.1016/j.econ-edurev.2016.11.008

Biewen, M., & Tapalaga, M. (2016). Life-cycle educational choices: Evidence for two German cohorts. *IZA Discussion Paper*, 9699.

chool Children | Intersection 1: Learning Pro-
cal Textbook for Chemistry Education | Pro-
ents' Influence on Students' STEM Career
cience | Workload-Adaptive Learning Envi-
pinnings of Mathematical Learning | Neu-
ID | Intersection 3: Clinical and Personality
Cues in Classroom Settings | Students' Emo-
tion in Children | Intersection 4: Language
oolbook Texts | How Can Foreign Grammar
Training of Scientific Presentation Skills | In-
ment, and Social Disparities | Environments
rough and out of Higher Education | Educa-
| **RESEARCH – RELEVANCE – RESPONSIBILITY**
ibility | Events and Cooperations | Events |
andidates | Facts and Figures | Graduates of
k | Awards of LEAD PhD Candidates | Budgeting
| Memberships in Boards and Committees |
LEAD | What is LEAD? | The LEADing Research
ng Program | Selected Research Projects | Re-
cation Sciences | Effects of Educational Policy
Quality and Teachers' Professional Competence

LEAD'S IMPACT ON SOCIETY

OUR MISSION*

As an integrated research and training program, the LEAD mission is to excel in terms of high-quality research on learning, educational achievement, and life course development, as well as in providing a superb learning environment for young researchers who will pursue a career in research or in leading non-research positions. Starting with the observation that educational practice and policy are often not guided by robust scientific knowledge, LEAD identified seven key questions in education that are systematically addressed in our research program. Furthermore, a central pillar of the LEAD mission is the conviction that research on education will fundamentally gain in terms of assessment, explanation, and intervention by bringing together researchers from different disciplines in a productive way.

SOCIETAL CONTRIBUTION OF OUR RESEARCH

The LEAD mission is closely linked to making a contribution to society. At the most general level, both in its research and training program, LEAD is inspired by the belief that decision-making in modern Western societies must stay attuned to the best scientific evidence available and that the dearth of robust scientific evidence in education has to be overcome.

At a more specific level, LEAD research centers around seven key questions in education that address for example the quality of teaching, effective learning environments and the potential of modern media in the classroom.

There is no doubt about both the relevance of these questions for educational practice



LEAD director Ulrich Trautwein taking part in the public panel discussion "More equal opportunities through education" with the minister of education of Baden-Württemberg Susanne Eisenmann.

*In reporting LEAD's impact on society, we use the framework proposed in "Evaluating the societal relevance of academic research: A guide" (ERIC publication 1001 EN, 2010).

and policy and the need for more solid research to better address these questions. In doing so, LEAD research typically takes on the form of use-inspired basic research and tackles research questions through assessment, explanation, and intervention.

How is LEAD research disseminated into society? It is important to emphasize that what is expected from researchers and what would be considered inappropriate in terms of dissemination differs considerably across different countries. There has been a shift in Germany that has caused researchers to more explicitly take into account the role of relevance and responsibility in research over the last years, but the role of researchers in the dissemination process differs between countries such as the U.S., Great Britain, and the Netherlands.

For instance, the concrete work at school or, more generally, with practitioners is not deemed to be within the sphere of researchers, but rather part of a professional support system located at a local, state, or federal level – even if this support system is, in parts, not as effective as it could be. Hence, LEAD is exploring and negotiating various ways to make our research important and available to practitioners.

At the moment, the LEAD dissemination strategy has three main goals. First, LEAD tries to contribute to a heightened awareness in decision makers of the important contribution of research for creating an effective educational system. Second, the LEAD training program lets young professionals acquire all the necessary knowledge to implement an evidence-oriented approach in educational decision making. Third, LEAD strives to make research findings widely available to the society through a number of different measures



LEAD member Christoph Randler giving a talk about chronobiology to interested teachers.

and target persons. LEAD members disseminate knowledge among several levels of stakeholders in addition to the scientific community including politicians and the

press, decision makers in administrations, school headmasters, teachers and teacher students, students and their parents, school psychologists, and therapists.

INDICATORS OF SOCIETAL RELEVANCE

For evaluating societal relevance, we considered the various interactions of the LEAD members with the diverse stakeholders. In the field of policymaking, LEAD members were offered important advisory board roles. Examples are:

- Josef Schrader, who is a member of the scientific advisory board “Literacy Decade” of the Federal Ministry of Education and Research in Germany,
- Pia Schober, who is a member of an expert committee of the EU Commission in the “Development of Early Childhood Education in Germany” (*Ausbau frühkindlicher Bildung und Betreuung in Deutschland*), and
- Ulrich Trautwein, who is the chairman of the advisory board of the Standing Conference of the Ministers of Education and Cultural Affairs (*Kultusministerkonferenz der Länder und Bundesministerium für Bildung und Forschung*) and the Federal Ministry of Education and Research which consults the federal and state governments on issues related to the performance of the German education system in comparison with other countries.

LEAD researchers are in great demand as experts and authors of articles in non-academic journals, magazines and newspapers, TV and radio broadcasts all over Germany. About 200 reports on LEAD members and their studies were published in 2016.

Members of LEAD were co-applicants of the successful grant application for creating the Tübingen School of Education (TüSE), and LEAD has been a TüSE partner since it was founded in 2015. TüSE is currently restructuring the teacher training at the University of Tübingen and has especially profited from LEAD's research infrastructure. Moreover, several LEAD members are active on the school board of the TüSE and as professors for methodology in teacher training. In this way, LEAD research results have a direct impact on teacher development.

LEAD also ensures that students and teachers profit from the results of the research network. Many schools in the vicinity of Tübingen participate in the

LEAD school partnership program. The willingness of schools to cooperate in this endeavor is indicative of their interest in new scientific insights.

In the context of the school partnership program, we also collaborate with the staff of the administration and ministry of Baden-Württemberg, which is another important aspect of our impact on society. Several of the representatives have accepted invitations to our retreats or to our Science Day, which has led to a continuous exchange of ideas. LEAD members have also been commissioned by the state of Baden-Württemberg to evaluate an important project involving the use of tablet computers in schools.

Further indicators of societal relevance are the increasing demand for lectures and the publication of research results in various textbooks. For example, Hogrefe Publishing House is now planning a book series on psychology in schools; two of the five editors are LEAD members.

ACTIVITIES IN RESEARCH TRANSLATION

- More than 60 talks and events for teachers and school authorities
- More than 35 publications for users, written by LEAD members (articles in journals and magazines, books, book series, webpages)
- More than 45 talks and events for the general public
- About 200 reports on LEAD members and their research in newspapers, online media, TV, radio and magazines (in 2016 only)



LEAD PhD candidate Friederike Blume presents her research to the interested public at an open day of the University of Tübingen.

DATA RESPONSIBILITY

LEAD is committed to collect the best possible data in research projects, and to use that data efficiently; furthermore to avoid any unnecessary strain on participants and wasteful use of resources. This responsibility is emphasized and established as a norm for researchers within LEAD as well as specifically emphasized in PhD training during orientation and at the initiation into LEAD.

Data collected in LEAD projects is used efficiently: Frequently multiple research projects combine efforts in collecting data together and creating a rich set of observations that can be used to answer multiple research questions from several different perspectives. Small-scale studies in field settings are generally discouraged, thereby minimizing the rate of false positive and false negative findings and reducing the burden on participating schools. Secondary data analyses are also common. This re-use of available data occurs particularly often between different LEAD projects and thus between different disciplines. In such cases data LEAD members share data to

answer different questions from different perspectives and methodological strategies. This not only uses data efficiently, but offers a unique opportunity to connect the different disciplines, expand the differentiated and ultimately integrative understanding of the studied phenomena, and encourages cross-(sub)disciplinary methodological development.

Data collection in large studies with many participants enables control and active management of the strain on schools and students. By carefully planning, combining and organizing large data collection projects and systematically keeping track of the schools and classes invited for participation, the quality of the data is greatly improved: Respondents and participants are exhausted due to an excessive number of studies conducted. Access to the field is conserved as a valuable resource for future studies. In addition, larger studies combining data collection for several research projects present a substantial saving of resources (e.g., research assistant hours, researchers' hours).



Data responsibility is also one of the recurring topics in the weekly LEAD colloquium.

The positive effects of responsible data collection planning for participants and the strain they are subject to at LEAD are additionally overseen by the newly founded ethics committee at the Faculty of Sciences (see box below). All research proposals within LEAD undergo review by the committee, which was created to meet the needs of LEAD, the Hector Research Institute of Education Sciences and Psychology and the Psychological Institute of the University of Tübingen. The ethics committee is also a strong component of the data responsibility policy at LEAD, aimed at further enhancing the conservation and sustainability of resources and protection of participants' privacy.

Increasing scientific discussions at LEAD focus on improving data efficiency not only by saving resources, but increasing the quality of data and study designs themselves. A growing number of recurring events (LEAD colloquium, LEAD seminar sessions) as well as talks and workshops are dedicated to improving the effectiveness and usefulness of the data collected.

In addition, the discussion about reproducible science in general has gained momentum. Various scientific communities are contributing more and more to a robust and cumulative body of scientific research. In this vein, LEAD is currently developing a research data archival policy that maximizes sustainability, re-usability and reliability of research procedures, analyses and inferences from empirical results. While LEAD itself strives to use original data and data from other sources efficiently through multiple usage, this policy will contribute greatly to making original data collected under the auspices of LEAD re-usable for third parties and amenable to exhaustion of their full potential. We are also discussing ways to systematically pre-register studies, share data with the scientific community through appropriate degrees of openness, and in general further enhance the documentation, traceability, and accountability of research processes. An initial version of a unified policy and fundamental steps towards its implementation are expected in the course of 2017.

ETHICS COMMITTEE

Being well aware of its responsibilities, LEAD has established an ethics committee together with the Faculty of Science and the Hector Research Institute of Education Sciences and Psychology, which follows the recommendations of the German Psychological Society (DGPs). The following LEAD members are involved in the ethics committee:

- **Caterina Gawrilow** (chairperson)
- **Benjamin Nagengast** (vice-chairperson)
- **Martin Hautzinger, Johanna Schmid** and **Jennifer Svaldi** (members)

Cues in Classroom Settings | Students' Emotion in Children | Intersection 4: Language Schoolbook Texts | How Can Foreign Grammar and Training of Scientific Presentation Skills Development, and Social Disparities | Environment, Through and out of Higher Education Outcomes | Research – Relevance – Responsibility | **EVENTS AND COOPERATIONS** of LEAD PhD Candidates | Facts and Figures & Research Network | Awards of LEAD PhD Candidates | Third-Party Funding | Memberships in LEAD PhD Candidates | About LEAD | What is Research Facility of LEAD | Training Program | The LEAD Starting Point: Education Programs in Upper Secondary School | Teaching Excellence | Enrichment Courses for Gifted Primary Processes and Outcomes | eChemBook: A | Promoting Motivation for Mathematics | Research Paths | Intersection 2: Educational Neuro-environments for Math | Neurocognitive Under-achievement Training for Children with ADHD | Intersection 3: Clinical and Personality

EVENTS

RETREATS

At the LEAD retreats, which take place twice a year, distinguished national and international guests are invited to give a talk or organize a discussion about key topics. These three-day events have proven to instigate productive network activities between PhD candidates as well as postdocs and faculty members. At its inception, 50 participants visited the retreat; in autumn 2016 we welcomed approximately 120 guests.



Eric Stice giving his keynote at the LEAD retreat 2015.

KEYNOTE SPEAKERS AT RETREATS

Marcel van Assen – Tilburg University
 Clancy Blair – New York University
 Lex Borghans – Maastricht University
 Kenneth Dodge – Duke University
 Alexander Grob – University of Basel
 Jeffrey Harring – University of Minnesota
 Paul Leleman – Utrecht University
 Oliver Lüdtke – Leibniz Institute for Science and Mathematics Education at Kiel University
 Kou Murayama – University of Reading
 Reinhard Pekrun – Ludwig-Maximilians-Universität München
 C. Cybele Raver – New York University
 Alexander Renkl – University of Freiburg
 Brent Roberts – University of Illinois at Urbana-Champaign
 Trudie Schils – Maastricht University
 Eric Stice – Oregon Research Institute/University of Texas at Austin
 Herman van de Werfhorst – University of Amsterdam
 Stephen G. West – Arizona State University/Freie Universität Berlin
 Allan Wigfield – University of Maryland

LEAD LECTURE SERIES

The LEAD Lecture Series takes place each semester. LEAD members invite national and international experts from their discipline to visit and give a lecture. Doctoral candidates are encouraged to meet individually with these guests to discuss research and career questions. "Meet-the-Expert" sessions are held to facilitate interaction between students and guests. About 50 guests have been invited since November

2012, among them Monique Boekaerts (Leiden University, Netherlands), Eckhard Klieme (German Institute for International Educational Research), Richard Ryan (Australian Catholic University), Maarten Vansteenkiste (Ghent University, Belgium), Herman van de Werfhorst (University of Amsterdam, Netherlands) and Stefan Wolter (University of Bern, Switzerland).



Clockwise from top left: Monique Boekaerts, Eckhard Klieme, Herman van de Werfhorst, Stefan Wolter, Maarten Vansteenkiste, and Richard Ryan.

TÜBINGEN SUMMER SERIES ON PERSONALITY PSYCHOLOGY

Since summer 2013, each year renowned international researchers specializing in personality psychology, social psychology, and economic science come to Tübingen to give lectures as a part of the Summer Series on Personality Psychology. About 20 speakers came to Tübingen to join the summer series.



Eva Pomerantz answering questions after her lecture at the Summer Series on Personality Psychology.

SPEAKERS IN THE SUMMER SERIES ON PERSONALITY PSYCHOLOGY

Mitja Back – Westfälische Wilhelms-Universität Münster
 Lex Borghans – Maastricht University
 Rodica Damian – University of Houston
 Jaap Denissen – Tilburg University
 Chris Fraley – University of Illinois
 Patrick Hill – Carleton University
 Robert Krueger – University of Minnesota
 Wenting Mu – University of Illinois at Urbana-Champaign
 Chris Nye – Michigan State University
 Eva Pomerantz – University of Illinois at Urbana-Champaign
 Brent Roberts – University of Illinois at Urbana-Champaign
 Richard W. Robins – University of California, Davis
 James Rounds – DePaul University
 Trudie Schils – Maastricht University
 Jule Specht – Freie Universität Berlin
 Rong Su – Purdue University
 Jennifer Tackett – University of Houston
 Simine Vazire – University of Texas at Austin

WINTER SCHOOL “RANDOMIZED CONTROLLED FIELD TRIALS”

In December 2016, LEAD organized together with the Hector Research Institute of Education Sciences and Psychology a winter school that provided in-depth insights into the design, implementation, and analysis of randomized controlled field trials (RCFTs) for 13 doctoral students that are affiliated with the University of Tübingen and for 12 junior researchers from the Netherlands and all over Germany.

RCFTs aim at evaluating educational interventions under realistic conditions and have gained increasing importance

in education sciences over the last years. RCFTs in the school context present a number of challenges regarding their standardized implementation and the consideration of the multilevel structure of the school context in design and analysis. The winter school was divided in five workshops, subsequent “Meet-the-Expert” sessions, and key notes. Gerard van Breukelen (Maastricht University), Larry Hedges (Northwestern University), Lindsay Page (University of Pittsburgh), and Carole Torgerson (Durham University) shared their expertise on the most relevant methodological aspects of RCFTs.



In several workshops, Larry Hedges from Northwestern University shared his expertise on randomized field trials.

EXTERNAL PARTNERS

LEAD actively maintains rich and fruitful relationships with several external partners, both national and international. Partners range from individual researchers to entire institutions. Moreover, the types of collaborations are manifold, including

shared supervision of PhD candidates, reciprocal lab visits and research projects, many of which have led to successful publications. The LEAD national and international partner network is still growing every year.

INSTITUTIONAL PARTNERS

LEIBNIZ-INSTITUT FÜR WISSENSMEDIEN IN TÜBINGEN (IWM)

- active role in the initial proposal for the LEAD Graduate School & Research Network
- active participation in the scientific and administrative processes within LEAD

GERMAN INSTITUTE OF ADULT EDUCATION – LEIBNIZ CENTRE FOR LIFELONG LEARNING IN BONN (DIE)

- official cooperation agreement
- PhD candidates of both LEAD and the DIE can attend seminars and training courses at the respective partner institution as part of their training program.
- reciprocal lab visits

TÜBINGEN DISTINGUISHED INTERNATIONAL PROFESSORSHIPS

- Clancy Blair, New York University, USA
- Jacquelynne Eccles, University of California, Irvine, USA
- Kou Murayama, University of Reading, UK
- Patrick Rebuschat, Lancaster University, UK
- Brent Roberts, University of Illinois, Urbana-Champaign, USA
- Herman van de Werfhorst, University of Amsterdam, NL
- Tamara van Gog, Utrecht University, NL



LEAD's Distinguished International Professors Brent W. Roberts, Tamara van Gog, and Clancy Blair.

NATIONAL AND INTERNATIONAL AFFILIATES

Stuart Kime – Durham University (since 2014)

Timo Stein – University of Amsterdam (since 2016)

Thorsten Zander – Technische Universität Berlin (since 2015)

Our national and international affiliates are important cooperation partners for both PhD candidates and faculty. Some of them have stayed in Tübingen for the duration of a semester as part of the Teach@Tübingen program (a fellowship offered by the University of Tübingen and supported by the German Research Foundation (ZUK 63)), others worked together with LEAD mem-

bers and were then affiliated. As affiliates, they are entitled to apply for intramural funding together with LEAD members and are welcome to participate in all LEAD events, e.g., the retreat. In return we expect them to support LEAD and its mission both actively and in spirit, e.g., by referring suitable PhD candidates to us.

INTERNATIONAL GUESTS

- Tzu-Ling Hua – Teach@Tübingen Fellow in 2014 (Durham University)
- Yi Jiang – Teach@Tübingen Fellow, Hector Research Institute of Education Sciences and Psychology, University of Tübingen in 2016 (Korea University)
- Juyeon Song – Teach@Tübingen Fellow, Hector Research Institute of Education Sciences and Psychology, University of Tübingen in 2016 (Korea University)



FEATURED: STUART KIME

Stuart Kime has been a LEAD-member since April 2014 when he came to Tübingen as a Teach@Tübingen fellow. He is the director of Evidence Based Education, a UK-based institution that helps schools and policy-makers around the world to better understand research evidence and use it to inform decision making. He studied for his PhD in Education at the University of Durham. Stuart is a regular guest at LEAD and teaches a seminar on “Research and Practice”.

FUTURE PLANNED COOPERATIONS

- **Cooperation with New York University:** LEAD is currently negotiating a cooperation with the Neuroscience and Education Lab, led by Clancy Blair and C. Cybele Raver, and the Motivation Lab, led by Peter Gollwitzer and Gabriele Oettingen at New York University. Additionally, Clancy Blair became one of LEAD's Distinguished International Professors in 2017.
- **Cooperation with the Centre of Evaluation and Monitoring (CEM) at Durham University:** LEAD is in the process of establishing an institutional cooperation with the Centre of Evaluation and Monitoring and the Department of Education at Durham University (UK). CEM is one of the leading centers of educational effectiveness research in the UK and has great expertise in engaging with stakeholders in schools and policy-making.
- **Cooperation with University of Maryland:** LEAD and the Hector Research Institute received funding from the University of Maryland and University of Tübingen International Collaboration on Research and Training in the Natural and Social Sciences to support collaborative research and student-faculty exchanges in 2015-16 and 2016-17. The group that encompasses educational psychologists and educational methodologists has developed new projects focusing on the measurement and development of motivation, and on methodological innovations for longitudinal data analysis.



LEAD is currently negotiating a cooperation with the Neuroscience and Education Lab of the New York University led by C. Cybele Raver and Clancy Blair.

LAB VISITS OF LEAD PHD CANDIDATES



| | |
|-----------------------------|---|
| Katharina Allgaier | Department of Psychology, University of Copenhagen, Denmark |
| Katharina Braungart | Department of Linguistics and English Language, Lancaster University, UK |
| Hanna Gaspard | School of Education, University of California Irvine, USA |
| Sebastian Grissmann | Department of Biological Psychology and Neuroergonomics, Technische Universität Berlin, Germany |
| Michael Grosz | Department of Psychology, University of Illinois at Urbana-Champaign, USA |
| Petra Haas | The Institute of Applied Health Sciences, University of Aberdeen, UK |
| Isabelle Häfner | Department of Psychology, University of Wisconsin-Madison, USA |
| Thomas Lösch | Leibniz Institute for Science and Mathematics Education, University of Kiel, Germany |
| Simón Ruiz Hernández | Department of Linguistics and English Language, Lancaster University, UK |
| Michèle Suhlmann | Center for Social and Cultural Psychology, University of Leuven, Belgium |
| Sowmya Vajjala | Center for Language Technology, University of Gothenburg, Sweden |
| Katarina Weßling | Research Centre for Education and the Labor Market, School of Business and Economics, Maastricht University, The Netherlands |

Education Sciences | Social Cues in Classroom
Promoting Self-Regulation in Children | Inter-
ic Complexity of Schoolbook Texts | How Can
Development and Training of Scientific Pre-
Life Course Development, and Social Dispari-
s | Pathways into, Through and out of Higher
nomic Outcomes | Research – Relevance – Re-
ta Responsibility | Events and Cooperations
LEAD PhD Candidates | **FACTS AND FIGURES**
& Research Network | Awards of LEAD PhD
ts | Third-Party Funding | Memberships in
LEAD PhD Candidates | About LEAD | What is
Research Facility of LEAD | Training Program
ogram | The LEAD Starting Point: Education
orms in Upper Secondary School | Teaching
nce | Enrichment Courses for Gifted Primary
ocesses and Outcomes | eChemBook: A Digi-
oting Motivation for Mathematics | Parents'
| Intersection 2: Educational Neuroscience |
for Math | Neurocognitive Underpinnings of
ining for Children with ADHD | Intersection

GRADUATES OF THE LEAD GRADUATE SCHOOL & RESEARCH NETWORK

The following list contains all LEAD graduates who submitted their dissertations by March 2017.

| NAME | TITLE OF DISSERTATION | POSITION SUBSEQUENT TO DISSERTATION | |
|--|-----------------------|---|--|
|  | Daniela Ahlberg | Embodiment in first and second language acquisition | Internship in psychiatry as requirement for obtaining the degree of psychotherapist |
|  | Katharina Allgaier | Honesty-humility at school: A person x situation approach to explain students' social behavior | Postdoctoral Researcher at Paediatric and Juvenile Psychiatry and Psychotherapy, University of Tübingen |
|  | Mirjam Frey | The significance of finger-based representations for numeric abilities – results of an intervention at the beginning of primary school and differentiation of structural features | Psychologist at the Clinic for Psychosomatic Medicine and Psychotherapy, Stuttgart Clinical Center |
|  | Hanna Gaspard | Promoting value beliefs in mathematics: A multidimensional perspective and the role of gender | Postdoctoral Researcher at LEAD/Hector Research Institute of Education Sciences and Psychology, University of Tübingen |
|  | Sebastian Grissmann | Investigating the prerequisites for a robust neurotutor: The detection of mixed user states containing working memory load, affective valence and affective dominance | Internship in psychiatry as requirement for obtaining the degree of psychotherapist |
|  | Petra Haas | Physical activity in children and adults – Associations with affect and impact on executive functions | Postdoctoral Researcher at LEAD Graduate School & Research Network, University of Tübingen |
|  | Isabelle Häfner | Investigating associations between family background and students' academic outcomes: The role of parents' motivation | Postdoctoral Researcher at LEAD/Hector Research Institute of Education Sciences and Psychology, University of Tübingen |

| NAME | TITLE OF DISSERTATION | POSITION SUBSEQUENT TO DISSERTATION |
|--|---|--|
|  | Evelin Herbein Public speaking training as an enrichment program for elementary school children: Conceptualization, evaluation, and implementation | Postdoctoral Researcher at LEAD/Hector Research Institute of Education Sciences and Psychology, University of Tübingen |
|  | Juliane Kant Fostering the acquisition of scientific reasoning with video modeling examples and inquiry tasks | Postdoctoral Researcher at LEAD/Hector Research Institute of Education Sciences and Psychology, University of Tübingen |
|  | Thomas Lösch Perceiving achievement in schools: How do self-appraisals, peer appraisals and achievement relate to each other? | Postdoctoral Researcher at the Chair for Personality Psychology and Psychological Assessment, University of Bamberg |
|  | Philipp Mock Using low-level sensor data to improve touchscreen interaction | Postdoctoral Researcher at Leibniz-Institut für Wissensmedien (IWM), Tübingen |
|  | Sina Müller Depressive symptoms in adolescence: Consequences, mechanisms, & school-based prevention efforts | Postdoctoral Researcher at LEAD Graduate School & Research Network, University of Tübingen |
|  | Juliane Richter Signaling text-picture relations in multimedia learning: The influence of prior knowledge | Postdoctoral Researcher and Coordinator of the Tübingen Digital Teaching Lab (TüDiLab) at Leibniz-Institut für Wissensmedien (IWM), Tübingen |
|  | Julia Schiefer Promoting and measuring elementary school children's understanding of science | Postdoctoral Researcher at LEAD/Hector Research Institute of Education Sciences and Psychology, University of Tübingen |
|  | Sowmya Vajjala Analyzing text complexity and text simplification: Connecting linguistics, processing and educational applications | Assistant Professor, Iowa State University, USA |
|  | Carina Walter EEG workload prediction in a closed-loop learning environment | Senior Data Analyst at TRON gGmbH, Mainz |
|  | Katarina Weßling The influence of socio-spatial contexts on transitions from school to vocational and academic training in Germany | Fritz Thyssen Postdoctoral Fellow at Cologne Graduate School, Institute of Sociology and Social Psychology, University of Cologne |

AWARDS OF LEAD PHD CANDIDATES

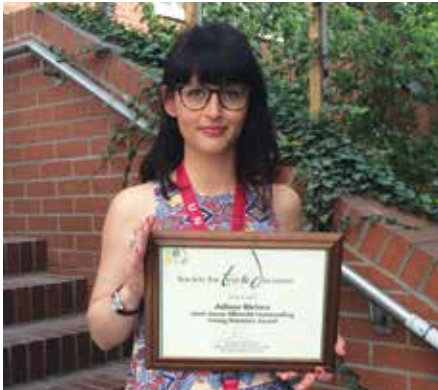

LEAD PhD candidate Juliane Richter received the Jason Albrecht Outstanding Young Scientist Award.

| | |
|--------------------|---|
| Katharina Allgaier | Poster award at the AERA, Division C (Learning and Instruction), Chicago, USA, 2015 |
| Gabriella Daroczy | Poster award at the international workshop "Domain-General and Domain-Specific Foundations of Numerical and Arithmetic Processing", Tübingen, Germany, 2016 |
| Hanna Gaspard | Highly Commended PhD Award by the Global SELF Research Network, 2015 AERA Motivation in Education SIG Graduate Student Presenter Travel Award, 2014 |
| Petra Haas | Poster award at the 30th conference of the European Society of Health Psychology (EHPS/DHP), Aberdeen, GB, 2016 |
| Isabelle Häfner | Young Researcher Award of the German Psychological Society (DGPS), Section Educational Psychology, Kassel, Germany, 2015 |
| Evelin Herbein | Award for the best presentation at the conference "Randomised Controlled Trials in the Social Sciences", York, GB, 2014 |
| Verena Hoehne | Award for the best poster at the conference "Randomised Controlled Trials in the Social Sciences", York, GB, 2014 Poster award at the 2nd annual conference of the Association of Empirical Educational Research (GEBF), Frankfurt/Main, Germany, 2014 |
| Juliane Richter | Jason Albrecht Outstanding Young Scientist Award, 26th annual meeting of the Society for Text and Discourse, Kassel, Germany, 2016 Junior Researcher Award for the "Best Paper Presentation" on the EARLI SIG2 Conference, Geneva, Switzerland, 2016 |
| Sven Rieger | Poster award at the 4th annual conference of the Association of Empirical Educational Research (GEBF), Berlin, Germany, 2016 |
| Julia Schiefer | Poster award at the 2nd Symposium of Education Sciences, Dortmund, Germany, 2016 Award for the best presentation at the conference "Randomised Controlled Trials in the Social Sciences", York, GB, 2014 |
| Sowmya Vajjala | Best poster award at the 16th International Conference on Intelligent Text Processing and Computational Linguistics, Cairo, Egypt, 2015 |
| Katarina Weßling | Travel Award of the Research Committee 28 on Social Stratification and Mobility in Bern, Switzerland, 2016 |

BUDGETING

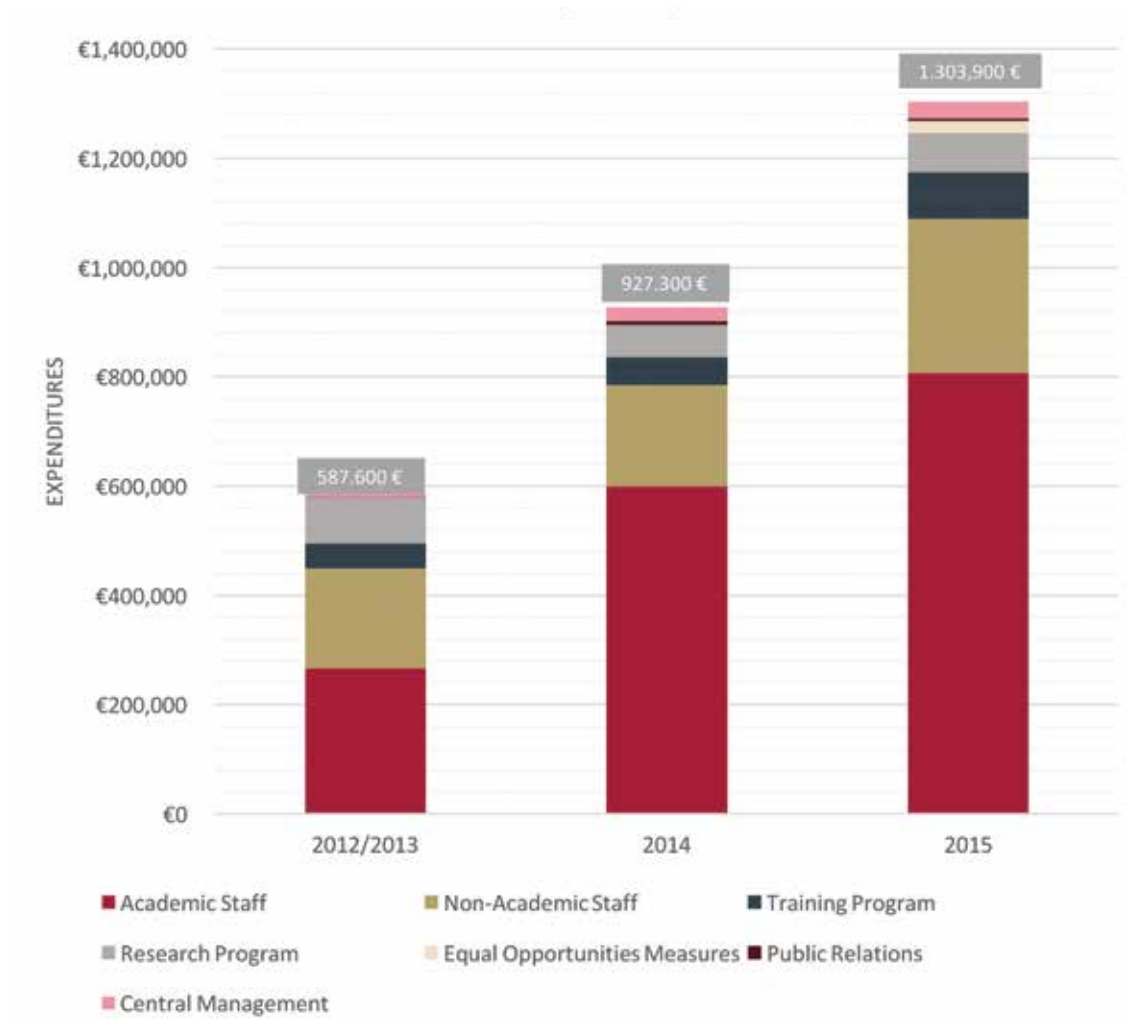

INTRAMURAL PROJECTS (NOV. 2012–JULY 2016)

All intramural research funding in LEAD is competitive. The LEAD Steering Board is authorized to approve projects up to 10,000 €; projects up to 20,000 € are reviewed by external experts.

APPLICANT

PROJECT TITLE

| | |
|--|---|
| Ahlberg, D., Bryant, D., & Kaup, B. | Differences in language processing in 1st & 2nd language learners of German |
| Ahlberg, D., Bryant, D., Kaup, B., & Bischoff, H. | Differences in language processing in first and second language learners of German |
| Allgaier, K. | Interaction between honesty-humility and contextual factors – predicting students social behavior in classical games and the classroom |
| Artemenko, C., & Dresler, T. | Stimulation intervention for dyscalculics |
| Artemenko, C., Dresler, T., Nürk, H.-C., Ehlis, A.-C., Bahnmüller, J., & Kadosh, R.-C. | Embodied number line training with portable devices |
| Artemenko, C., Nürk, H.-C., & Ehlis, A.-C. | Neurofunctional foundations of arithmetic processes |
| Berendes, K., Vajjala, S., Meurers, D., & Bryant, D. | Reading demands in Hauptschule and Gymnasium: A comparison of the linguistic complexity of schoolbook texts |
| Blume, F., Göllner, R., Dresler, T., Ehlis, A.-C., & Gawrilow, C. | The influence of teachers' instructional behaviour on children's learning in a virtual classroom environment: Differences between schoolchildren with and without attention-deficit/hyperactivity disorder (ADHD) |
| Blume, F., Hudak, J., Gawrilow, C., Ehlis, A.-C., & Dresler, T. | A NIRS-based neurofeedback training in a virtual classroom environment in schoolchildren with attention-deficit/hyperactivity disorder (ADHD) |
| Braungart, K., Kaup, B., & Meurers, D. | Aspects of foreign grammar learning using Latin |
| Bugl, P., Gawrilow, C., Schmid, J., Kelava, A., Wolf, S., & Sudeck, G. | Promoting self-regulation and executive functions in children: Evaluating the effectiveness of brief physical activity interventions |
| Cress, U., & Wolska, M. | Cues of (un)objectivity in expository discourse: The case of Wikipedia |
| Daroczy, G., Wolska, M., Meurers, D. Nürk, H.-C., & Dresler, T. | Mathematic and linguistic factors in solution of word problems: Children-larger scale study & neurocognitive foundation |
| Gaspard, H., & Häfner, I. | Assessment of students' task values, engagement, and family background and their interrelations in secondary school |
| Gawrilow, C., Kelava, A., Renner, T., Schmid, J., Conzelmann, A., Dürrwächter, U., & Fiege, C. | From day hospital back to school: Identifying conditions for successful school reintegration |
| Gerjets, P., Grissmann, S., & Walter, C. | Towards passive brain computer interfaces in educational contexts — bridging the gap between the field and the lab |
| Grissmann, S., & Gerjets, P. | Investigating the usability of a mobile EEG device for the detection of attention, workload and emotional user states |
| Hartung, A., Weßling, K., & Hillmert, S. | Favourable local environments and educational success |

| APPLICANT | PROJECT TITLE |
|--|---|
| Hellwig L., & Göllner, R. | Classroom quality matters! School-based depression prevention outcome and classroom quality |
| Hellwig, L., Gawrilow, C., Renner, T., Schmid, J., & Dürrwächter, U. | Video analysis of ADHD symptoms in simulated classrooms |
| Hua, T.-L., & Meurers, D. | How is English language teaching informed by the developmental sequences identified in SLA research: An analysis of English textbooks in Taiwan |
| Jusyte, A. | Alterations of social information processing in aggression-prone individuals: Investigation of perceptual, neural, and cognitive risk factors |
| Jusyte, A., & Göllner, R. | Processing of relevant social cues in classroom settings: an explorative study |
| Jusyte, A., & Hautzinger, M. | Counteracting adolescent depression: Implementation of the school-based universal prevention program 'Lars & Lisa' |
| Kant, J., Scheiter, K., & Oschatz, K. | Fostering scientific reasoning with worked examples of simulated experiments |
| Kant, J., Scheiter, K., & Oschatz, K. | Do learners need an inquiry task when learning how to experiment with video modeling examples of virtual experiments? |
| Lang, F., Oschatz, K., Gerjets, P., & Kammerer, Y. | Domain- and context-specific aspects of epistemic cognition |
| Lipphardt, C., Kramer, O., & Scheiter, K. | Assessing competence of vivid language use through specific rhetorical training |
| Mock, P., Tibus, M., Gerjets, P., Trautwein, U., & Rosenstiel, W. | The human touch: What do multi-touch interaction patterns during academic task performance reveal about personality and motivational variables? |
| Ruiz-Hernandez, S., Meurers, D., Kaup, B., & Scheiter, K. | Automatic input enhancement of authentic materials for language learning |
| Ruth, F., Herbein, E., Fauth, B., Kramer, O., & Trautwein, U. | Assessing presentation competence through video-based observations |
| Schmid, J., Fiege, C., Kelava, A., & Gawrilow, C. | Dynamics of adaptation in the transition from middle school to high school and vocational training: The role of emotion-regulation, inhibition-related functions, and self-regulation |
| Siegmund, B., Bryant, D., Nagengast, B., & Meurers, D. | Building academic language in science classes at the transition from primary to secondary school – an intervention study using scaffolding techniques and focus-on-form instruction |
| Suhlmann-Dawud, M., Sassenberg, K., Trautwein, U., & Nagengast, B. | Explaining ethnic disparities in German universities with cultural mismatch and decreased feeling of belonging to the university |
| Vagvölgyi, R., Nürk, H.-C., Schrader, J., Kaup, B., Dresler, T., & Nagengast, B. | Basic foundations of functional illiteracy |
| Vajjala, S., Meurers, D., Jonkmann, K., & Keßler, J.-U. | Towards appropriate reading material for bilingual classrooms (ReBil): Evaluating the role of linguistic complexity analysis and text simplification in authentic contexts |
| Vajjala, S., Meurers, D., & Scheiter, K. | Linking linguistic & cognitive measures of text complexity |
| Wasner, M., & Nürk, H.-C. | Neurocognitive correlates of finger counting |
| Wille, E., & Gaspard, H. | Effects of a gender stereotyped math television show on girls' and boys' motivation, attitudes and achievement in math |
| Wolska, M. | Eye-tracking for user-adaptive systems in education (eyeUSE) subproject: Predicting performance on reading comprehension items using eye-tracking |
| Wolska, M., Nürk, H.-C., Meurers, D., & Daroczy, G. | Linguistic and mathematical factors in word problem solving |

THIRD-PARTY FUNDING

Throughout the existence of LEAD, its members have been successfully applying for third-party funds. The following overview presents those applications from which new research and training structures have been developed that are relevant for LEAD. Additionally, from November 2012 through July 2016, the LEAD Faculty has applied successfully for a total of 25 projects at the German Research Foundation (DFG) as well as for a large number of projects at the Federal Ministry of Education and Research (BMBF).

Cress, U., Scheiter, K., Sassenberg, K., & Hesse, F. W., Postdoc Network on Conflicts in Media Use - A Cognitive Approach. Leibniz Association, 884.400 €, 2016–2019.

Engler, B., Amos, K., Bohl, T., **Gawrilow, C., Hesse, F., & Trautwein, U.**, Tübingen School of Education (TüSE). Federal Ministry of Education and Research (BMBF), 5.288.076 €, 2016–2019.

Hesse, F., Schrader, J., Trautwein, U. & Scheiter, K., Framework Proposal for the DFG Research Group: Analyzing and promoting effective processes of learning and instruction (phase III). German Research Foundation (DFG), 274.000 €, 2014–2016.

- ◆ The DFG research group was a major starting point for the prosperity of education research in Tübingen and one of the reasons for the success of LEAD. The group was one of only three out of a total of 21 applications, which was funded by the DFG as part of the program "Education Sciences". At the end of the third phase, the research group was successfully completed in 2016 and all activities were transferred into LEAD.

Kramer, O., Presentation Research Center and project "Jugend präsentiert" ["Youth Presents"]. Klaus Tschira Foundation, 2.500.000 €, 07/2016–06/2021.

Leibniz-Institut für Wissensmedien, University of Tübingen, WissenschaftsCampus II [Science Campus II]. Funded by the University of Tübingen, Leibniz-Institut für Wissensmedien, Leibniz Association, Ministry of Science, Research, and the Arts of the state of Baden-Württemberg, ca. 1.000.000 €, 2017–2020.

Scheiter, K., TüDiLab - Fostering professional knowledge in a digital teaching lab. Ministry of Science, Research, and the Arts of the state of Baden-Württemberg, 940.000 €, 2016–2021.

- ◆ In 2016, the Tübingen Digital Teaching Lab (TüDiLab) was opened at the Leibniz-Institut für Wissensmedien with the strong participation of several LEAD members (Fauth, B., Gawrilow, C., Hesse, F. W., Schmidt-Hertha, B., Schrader, J., Trautwein, U.). The TüDiLab is designed to train prospective teachers of all disciplines for media-based teaching. Student teachers will be able to test and further develop digital teaching concepts with digital media typical for schools. In addition, the TüDiLab enables research on the characteristics and effects of media-based teaching which is a core research field within LEAD.



Members of the School Board of the Tübingen School of Education visiting the TüDiLab.

Trautwein, U., & colleagues, Rahmenkonzeption für das Netzwerk Bildungsforschung [Framework Proposal for Network on Educational Research]. Baden-Württemberg Foundation, phase I, 2013–2016, 2.000.000 €; phase II, 1.500.000 €, 2016–2019.

Trautwein, U., Nagengast, B., & Kelava, A., Tübinger Postdoktorandenakademie für Empirische Bildungsforschung [Postgraduate Academy for Education Sciences]. Ministry of Science, Research, and the Arts of the state of Baden-Württemberg, 1.800.000 €, 2015–2020.

Trautwein, U., Nagengast, B., & Kelava, A., Endowed Research Institute: Hector Research Institute of Education Sciences and Psychology. Hector Foundation II, 7.500.000 €, 2014–2024.

- ◆ In September 2014, the Hector Research Institute of Education Sciences and Psychology was founded at the Tübingen University, which will be supported financially for ten or more years by the Hector Foundation II. The generous funding is, to a large extent, a consequence of LEAD's success in the Excellence Initiative of the German federal and state governments. Together with LEAD and other existing institutions, the new institute strengthens Tübingen as a center for high-level research on education.



Theresia Bauer, Minister of Science of Baden-Württemberg, and Bernd Engler, President of the University of Tübingen, sign the agreement for the founding of the Hector Research Institute of Education Sciences and Psychology.

MEMBERSHIPS IN BOARDS AND COMMITTEES

LEAD members take on numerous administrative functions in boards and committees – be it at a scientific, political or social level. In more than 100 activities as consultants, speakers, and editors, they contribute their expertise, including for example:

- ◆ Member of the Advisory Board for the Reporting on Poverty and Wealth by the Federal Ministry of Labor and Social Affairs (Martin Biewen)
- ◆ Member of the Board of Consulting Editors of the “Educational Psychologist”, Impact Factor SSCI 4.8 (Ulrike Cress)
- ◆ Member of the Advisory Board of the Federal Institute for Vocational Education & Training, Bonn (Kerstin Pull)
- ◆ Member of the Scientific Advisory Board “Literacy Decade” for the Federal Ministry of Education and Research (Josef Schrader)
- ◆ Member of the Round Table “Future of PE Teacher Education” at the Ministry of Education, Youth and Sports Baden-Württemberg (Ansgar Thiel)

From 2012 to 2016, Andreas J. Fallgatter was an **elected member of the German Research Foundation (DFG)**. Within the review board "Neurosciences", he had to co-decide on all individual applications, as well as on research groups and other coordinated initiatives.



Since November 2010, Friedrich W. Hesse has been the scientific **vice president of the Leibniz Association**, one of the largest research organizations in Germany, which unites 91 independent research institutes from various disciplines. They range from natural sciences, engineering sciences, environmental sciences, economics, space and social sciences to the humanities. Leibniz Institutes devote themselves to socially, economically and ecologically relevant questions. The Leibniz Institutes employ about 18,600 people, including 9,500 scientists. The institutes' total budget is more than 1.7 billion euros.



Since 2015, Ulrich Trautwein has been **chair of the Advisory Board of the Standing Conference of the Ministers of Education and Cultural Affairs and the Federal Ministry of Education and Research** for the joint task of Bund and Länder. In this function, he advises the leading education policy-makers in Germany.



PUBLICATIONS OF LEAD FACULTY MEMBERS

Between 2012 and 2016, the LEAD Faculty published several hundred publications in international peer-reviewed journals.

PUBLICATIONS

PUBLICATIONS OF LEAD PHD CANDIDATES

This list only contains papers that are in press or already published. It also includes conference proceedings in the area of computer science and computational linguistics, which are the most important mode of publication in these fields.

- Allgaier, K., Zettler, I., Wagner, W., Püttmann, S., & Trautwein, U.** (2015). Honesty-humility in school: Exploring main and interaction effects on secondary school students' antisocial and prosocial behavior. *Learning and Individual Differences, 43*, 211–217. doi:10.1016/j.lindif.2015.08.005
- Artemenko, C., Daroczy, G., & Nuerk, H.-C.** (2015). Neural correlates of math anxiety – an overview and implications. *Frontiers in Psychology, 6*. doi:10.3389/fpsyg.2015.01333
- Artemenko, C., Moeller, K., Huber, S., & Klein, E.** (2015). Differential influences of unilateral tDCS over the intraparietal cortex on numerical cognition. *Frontiers in Human Neuroscience, 9*. doi:10.3389/fnhum.2015.00110
- Bellhäuser, H., **Lösch, T.**, Winter, C., & Schmitz, B. (2016). Applying a web-based training to foster self-regulated learning: Effects of an intervention for large numbers of participants. *The Internet and Higher Education, 31*, 87–100. doi:10.1016/j.iheduc.2016.07.002
- Biewen, M., & Tapalaga, M.** (2017). Life-cycle educational choices in a system with early tracking and 'second chance' options. *Economics of Education Review, 56*, 80–94. doi:10.1016/j.econedurev.2016.11.008
- Biewen, M., & Tapalaga, M.** (2016). Life-cycle educational choices: Evidence for two German cohorts. *IZA Discussion Paper, 9699*.
- Blume, F., Hudak, J., Dresler, T., Kühnhausen, J., Renner, T. J., Ehlis, A.-C., & Gawrilow, C.** (2017). NIRS-based Neurofeedback Training in a Virtual Reality Classroom in Children with ADHD. *Trials, 18*. doi:10.1186/s13063-016-1769-3
- Borchers, M., **Mock, P.**, Zahn, C., Edelmann, J., & **Hesse, F.** (2013). Supporting school group visits to fine arts museums in the 21st century: A CSCL concept for a multi-touch table based video tool. *Proceedings of the 10th International Conference on Computer Supported Collaborative Learning 2013, USA*, 57–64.
- Bryant, D., & Rummel, S. C.** (2016). Nachhaltige dramapädagogische Sprachförderung für Grundschul Kinder mit DaZ. Ein durchgängiges Förderkonzept: Vom außerschulischen Feriencamp zur fachsensiblen Sprachförderung in schulischer Theater-AG [Sustainable theater pedagogical language support for primary school children with German as a second language. An integrated support framework: From the extracurricular holiday camp to sensible language promotion in school theater]. *Scenario – Zeitschrift für Drama- und Theaterpädagogik in der Fremd- und Zweitsprachenvermittlung, 1*, 7–32.
- Bugl, P., Schmid, J., & Gawrilow, C.** (2015). Ambulantes Assessment in der Schule: Den schulischen Alltag erfahrbar machen [Ambulatory assessment in school: Discovering daily school life]. *Lernen und Lernstörungen, 4*, 261–268. doi: 10.1024/2235-0977/a000115
- Chen, X., & Meurers, D.** (2016). Characterizing text difficulty with word frequencies. *Proceedings of the 11th Workshop on Innovative Use of NLP for Building Educational Applications, USA*, 84–94.
- Chen, X., & Meurers, D.** (2016). CTAP: A web-based tool supporting automatic complexity analysis. *Proceedings of the Workshop on Computational Linguistics for Linguistic Complexity, Japan*, 113–119.
- Chinkina, M., & Meurers, D.** (2016). Linguistically aware information retrieval: Providing input

enrichment for second language learners. *Proceedings of the 11th Workshop on Innovative Use of NLP for Building Educational Applications, USA*, 188–198.

Chinkina, M., Kannan, M., & Meurers, D. (2016). Online information retrieval for language learning. *Proceedings of 54th Annual Meeting of the Association for Computational Linguistics: System Demonstrations, Germany*, 7–12.

Daroczy, G., Wolska, M., Meurers, W. D., & Nuerk, H-C. (2015). Word problems: A review of linguistic and numerical factors contributing to their difficulty. *Frontiers in Psychology*, 6. doi:10.3389/fpsyg.2015.00348

Edelmann, J., **Mock, P.**, Schilling, A., & **Gerjets, P.** (2013). Preserving non-verbal features of face-to-face communication for remote collaboration. *Proceedings of the 10th International Conference on Cooperative Design, Visualization & Engineering 2013, Spain*.

Edelmann, J., **Mock, P.**, Schilling, A., **Gerjets, P.**, **Rosenstiel, W.**, & Strasser, W. (2012). Towards the keyboard of Oz: Learning individual SoftKeyboard models from raw optical sensor data. *Proceedings of the 11th International Conference on Intelligent Tutoring Systems, Greece*.

Gaspard, H., Dicke, A.-L., Flunger, B., Brisson, B. M., Häfner, I., Nagengast, B., & Trautwein, U. (2015). Fostering adolescents' value beliefs for mathematics with a relevance intervention in the classroom. *Developmental Psychology*, 51, 1226–1240.

Gaspard, H., Dicke, A.-L., Flunger, B., Schreier, B., Häfner, I., Trautwein, U., & Nagengast, B. (2015). More value through greater differentiation: Gender differences in value beliefs about math. *Journal of Educational Psychology*, 107, 663–677

Gaspard, H., Häfner, I., Parrisius, C., Trautwein, U., & Nagengast, B. (2016). Assessing task values in five subjects during secondary school: Measurement structure and mean level differences across grade level, gender, and academic subject. *Contemporary Educational Psychology*. Advance online publication. doi:10.1016/j.cedpsych.2016.09.003

Gerjets, P., Walter, C., Rosenstiel, W., Bogdan, M., & Zander, T. O. (2014). Cognitive state monitoring and the design of adaptive instruction in digital environments: Lessons learned from cognitive workload assessment using a passive brain-computer interface approach. *Frontiers in Neuroscience*, 8. doi:10.3389/fnins.2014.00385

Grissmann, S., Brönstrup, J., Faller, J., Kelava, A., Zander, T.O., & Gerjets, P. (2015). Holistic user state models in human-machine interaction. *Proceedings of the 11th Berliner Werkstatt Mensch-Maschine Systeme, Germany*, 22–23. doi:10.14279/depositonce-4887

Grosz, M. P., Emons, W. H. M., Wetzel, E., Leckelt, M., Chopik, W. J., Rose, N., & Back, M. D. (2017). A comparison of unidimensionality and measurement precision of the narcissistic personality inventory and the narcissistic admiration and rivalry questionnaire. *Assessment*. doi:10.1177/1073191116686686

Haas, P., Schmid, J., Stadler, G., Reuter, M., & Gawrilow, C. (2017). Zooming into daily life: Within-person associations between physical activity and affect in young adults. *Psychology & Health*, 32, 588–604. Advance online publication. doi:10.1080/08870446.2017.1291943

Häfner, I., Flunger, B., Dicke, A.-L., Gaspard, H., Brisson, B. M., Nagengast, B., & Trautwein, U. (in press). A Robin Hood effect on math motivation: Family background moderates the effects of relevance interventions. *Developmental Psychology*.

Häfner, I., Flunger, B., Dicke, A.-L., Gaspard, H., Brisson, B. M., Nagengast, B., & Trautwein, U. (2017). The role of family characteristics for students' academic outcomes: A person-centered approach. *Child Development*. Advance online publication. doi:10.1111/cdev.12809

Hübner, N.*, Wille, E.*, Cambria, J., Oschatz, K., Nagengast, B., & Trautwein, U. (2017). Maximizing

gender equality in STEM by minimizing course choice options? Effects of obligatory coursework in math on gender differences in STEM. *Journal of Educational Psychology*. Advance online publication. doi:10.1037/edu0000183 *The first two authors contributed equally to this work and are listed in alphabetical order.

Hübner, N., Wagner, W., Kramer, J., **Nagengast, B., & Trautwein, U.** (2017). Die G8-Reform in Baden-Württemberg: Leistungen, Wohlbefinden und Freizeitverhalten vor und nach der Reform. [The G8 reform in Baden-Württemberg: Competencies, wellbeing and leisure time before and after the reform]. *Zeitschrift für Erziehungswissenschaft*. Advance online publication. doi: 10.1007/s11618-017-0737-3

Martin, A., & **Rüber, I. E.** (2016). Die Weiterbildungsbeteiligung von Geringqualifizierten im internationalen Vergleich – Eine Mehrebenenanalyse [The participation in continuing training of low-skilled workers compared internationally – A multi-level analysis]. *Zeitschrift für Weiterbildungsforschung – Report*, 39, 149–169.

Marx, C., Goeze, A., **Voss, T., Hoehne, V.,** Klotz, V., & **Schrader, J.** (2017). Pädagogisch-psychologisches Wissen von Lehrkräften aus Schule und Erwachsenenbildung: Entwicklung und Erprobung eines Testinstruments [Pedagogical- psychological knowledge of teachers from school and adult education: Development and testing of a test instrument]. *Zeitschrift für Erziehungswissenschaft*, 20, 165–200. doi:10.1007/s11618-017-0733-7

Mayer, K., **Blume, F.,** Wyckoff, S. N., Brokmeier, L. L., & Strehl, U. (2015). Neurofeedback of slow cortical potentials as a treatment for adults with Attention Deficit-/Hyperactivity Disorder. *Clinical Neurophysiology*, 127, 1374–1386. doi:10.1016/j.clinph.2015.11.013

Mock, P., Edelmann, J., & **Rosenstiel, W.** (2015). Learning instead of markers: Flexible recognition of mobile devices on interactive surfaces. *Proceedings of the 17th International Conference on Human-Computer Interaction, USA*, 325–336. doi:10.1007/978-3-319-20804-6_30

Mock, P., Edelmann, J., Schilling, A., & **Rosenstiel, W.** (2014). User identification using raw sensor data from typing on interactive displays. *Proceedings of the International Conference on Intelligent User Interfaces, Israel*, 67–72. doi:10.1145/2557500.2557503

Mock, P., Gerjets, P., Tibus, M., Trautwein, U., Möller, K., & Rosenstiel, W. (2016). Using touchscreen interaction data to predict cognitive workload. *Proceedings of the 18th ACM International Conference on Multimodal Interaction, Japan*, 349–356. doi:10.1145/2993148.2993202

Mock, P., Jaszkwic, J., Edelmann, J., Kammerer, Y., Schilling, A., & **Rosenstiel, W.** (2015). keyValuate: A framework for rapid evaluation of adaptive keyboards on touchscreens. *Proceedings of 27th Australian Conference on Human-Computer Interaction, Australia*, 361–369. doi:10.1145/2838739.2838744

Müller, S., Jusyte, A., Trzebiatowski, S., **Hautzinger, M.,** & **Schönenberg, M.** (2016). Processing of ambiguous facial affect in adolescents with depressive symptoms prior to and following social exclusion: The role of perceptual sensitivity and response bias. *Journal of Psychopathology and Behavioral Assessment*. Advance online publication. doi:10.1007/s10862-016-9582-6

Müller, S., & Stice, E. (2013). Moderators of the intervention effects for a dissonance-based eating disorder prevention program; results from an amalgam of three randomized trials. *Behaviour Research and Therapy*, 51, 128–133.

Müller, S., Rohde, P., Gau, J. M., & Stice, E. (2015). Moderators of the effects of indicated group and bibliotherapy cognitive behavioral depression prevention programs on adolescents' depressive symptoms and depressive disorder onset. *Behaviour Research and Therapy*, 75, 1–10.

Oestermeier, U., **Mock, P.,** Edelmann, J., & **Gerjets, P.** (2015). LEGO Music: Learning composition with bricks. *Proceedings of the 14th International Conference on Interaction Design and Children, USA*, 283–286. doi:10.1145/2771839.2771897

- Richter, J., Scheiter, K., & Eitel, A.** (2016). Signaling text-picture relations in multimedia learning: A comprehensive meta-analysis. *Educational Research Review, 17*, 19–36. doi:10.1016/j.edurev.2015.12.003.
- Rieger, S., Göllner, R., Trautwein, U., & Roberts, B. W.** (2016). Low self-esteem prospectively predicts depression in the transition to young adulthood: A replication of Orth, Robins, and Roberts (2008). *Journal of Personality and Social Psychology, 110*, e16–e22. doi:10.1037/pspp0000037
- Roesch, S., Jung, S., Huber, S., **Artemenko, C.**, Bahnmueller, J., Heller, J., Grust, T., **Nuerk, H.-C., & Moeller, K.** (2016). Training arithmetic and orthography on a web-based and socially-interactive learning platform. *International Journal of Education and Information Technologies, 10*, 204–217.
- Rothenbusch, S., Zettler, I., **Voss, T., Lösch, T., & Trautwein, U.** (2016). Exploring reference group effects on teachers' nominations of gifted students. *Journal of Educational Psychology, 108*, 883–897. doi:10.1037/edu0000085
- Schreier, B., Dicke, A.-L., **Gaspard, H., Häfner, I.**, Flunger, B., Lüdtke, O., **Nagengast, B., & Trautwein, U.** (2014). Der Wert von Mathematik im Klassenzimmer: Die Bedeutung relevanzbezogener Unterrichtsmerkmale für die Wertüberzeugungen der Schülerinnen und Schüler [The value of mathematics in the classroom: The importance of relevant teaching features for the value beliefs of the students]. *Zeitschrift für Erziehungswissenschaft, 17*, 225–255.
- Spüler, M., **Walter, C., Rosenstiel, W., Gerjets, P., Moeller, K., & Klein, E.** (2016). EEG-based prediction of cognitive workload induced by arithmetic: A step towards online adaptation in numerical learning. *ZDM Mathematics Education, 48*, 267–278. doi:10.1007/s11858-015-0754-8
- Tagarelli, K.M., **Ruiz, S.**, Moreno Vega, J.L., & **Rebuschat, P.** (2016). Variability in second language learning: The roles of individual differences, learning conditions, and linguistic complexity. *Studies in Second Language Acquisition. Special Issue on Cognitive Perspectives on Difficulty and Complexity in SLA, 38*, 293–316. doi:10.1017/S0272263116000036
- Trautwein, U., Nagengast, B.**, Marsh, H. W., **Gaspard, H.**, Dicke, A.-L., Lüdtke, O., & Jonkmann, K. (2013). Expectancy-value theory revisited. From expectancy-value theory to expectancy-values theory? In D. M. McInerney, H. W. Marsh., R. G. Craven & F. Guay (Eds.), *Theory driving research: New wave perspectives on self-processes and human development* (pp. 233–249). Charlotte, NC: Information Age Publishing.
- Ulrich, N., **Richter, J., Scheiter, K.**, & Schanze, S. (2014). eChemBook: ein interaktives, digitales Schulbuch für den Chemieunterricht [eChemBook: an interactive, digital textbook for chemistry lessons]. In M. Schuhen & M. Froitzheim (Eds.), *Das Elektronische Schulbuch. Fachdidaktische Anforderungen und Ideen treffen auf Lösungsvorschläge der Informatik* (pp. 31–42). Münster: LIT Verlag.
- Vágvölgyi, R.**, Coldea, A., **Dresler, T., Schrader, J., & Nuerk, H.-C.** (2016). A review about functional illiteracy: Definition, cognitive, linguistic, and numerical aspects. *Frontiers in Psychology, 7*. doi:10.3389/fpsyg.2016.01617
- Voss, T.**, Kunina-Habenicht, O., **Hoehne, V.**, & Kunter, M. (2015). Stichwort Pädagogisches Wissen von Lehrkräften: Empirische Zugänge und Befunde [Teachers' pedagogical knowledge: Empirical approaches and findings]. *Zeitschrift für Erziehungswissenschaft, 18*, 187–223. doi:10.1007/s11618-015-0626-6
- Voss, T.**, Kunter, M., Seiz, J., **Hoehne, V.**, & Baumert, J. (2014). Die Bedeutung des pädagogisch-psychologischen Wissens von angehenden Lehrkräften für die Unterrichtsqualität [The significance of the pedagogical-psychological knowledge of future teachers for the quality of teaching]. *Zeitschrift für Pädagogik, 60*, 184–201. doi:10.3262/ZP1402184
- Walter, C.**, Schmidt, S., **Rosenstiel, W., Gerjets, P., & Bogdan, M.** (2013). Using cross-task classification for classifying workload levels in complex learning tasks. *Proceedings of the 5th Humane Association*

Conference on Affective Computing and Intelligent Interaction, 876–881.

Walter, C., Wolter, P., Spüler, M., **Rosenstiel, W.**, & Bogdan, M. (2014). Towards cross-subject workload prediction. *Proceedings of the 6th International Brain-Computer Interface Conference*, 190–193. doi:10.3217/978-3-85125-378-8-30

Wasner, M., **Moeller, K.**, Fischer, M. H., & **Nuerk, H.-C.** (2014). Aspects of situated cognition in embodied numerosity: The case of finger counting. *Cognitive Processing*, 15, 317–328. doi:10.1007/s10339-014-0599-z

Wasner, M., **Moeller, K.**, Fischer, M. H., & **Nuerk, H.-C.** (2014). Related but not the same: Ordinality, cardinality and 1-to-1 correspondence in finger-based numerical representations. *Journal of Cognitive Psychology*, 7, 426–441. doi:10.1080/20445911.2014.964719

Wasner, M., **Nuerk, H.-C.**, Martignon, L., Roesch, S., & **Moeller, K.** (2016). Finger gnosis predicts a unique but small part of variance in initial arithmetic performance. *Journal of Experimental Child Psychology*, 146, 1–16. doi:10.1016/j.jecp.2016.01.006

Weßling, K., & Wicht, A. (2015). Möglichkeiten der Nutzung regionaler Daten im Nationalen Bildungspanel (NEPS) – ein Überblick [Possibilities of utilising regional data for the National Educational Panel Study (NEPS) – an overview]. *NEPS Working Paper 54*. Retrieved from https://www.neps-data.de/Portals/0/Working%20Papers/WP_LIV.pdf

Weßling, K., **Hartung, A.**, & **Hillmert, S.** (2015). Spatial structure counts: The relevance of regional labour-market conditions for educational transitions to vocational training, *Empirical Research in Vocational Education and Training*, 7. doi: 10.1186/s40461-015-0024-6

Wurm, M.F., **Artemenko, C.**, Giuliani, D., & Schubotz, R.I. (2017). Action at its place: Contextual settings enhance action recognition in 4- to 8-year-old children. *Developmental Psychology*. Advance online publication. doi:10.1037/dev0000273

Wurst, S. N., Gerlach, T. M., Dufner, M., Rauthmann, J. F., **Grosz, M. P.**, Kufner, A. C. P., Denissen, J. J. A., & Back, M. D. (2017). Narcissism and romantic relationships: The differential impact of narcissistic admiration and rivalry. *Journal of Personality and Social Psychology*, 112, 280–306. Retrieved from <http://psycnet.apa.org/journals/psp/112/2/280/>

Ziegler, N., **Meurers, D.**, **Rebuschat, P.**, **Ruiz, S.**, Moreno, J. L., **Chinkina, M.**, & Grey, S. (2017). Interdisciplinary research at the intersection of CALL, NLP, and SLA: Methodological implications from an input enhancement project. *Language Learning*. doi:10.1111/lang.12227

PUBLISHER

University of Tübingen
LEAD Graduate School & Research Network
Gartenstrasse 29
72074 Tübingen
Germany
+49 7071 29-73574
www.lead.uni-tuebingen.de

EDITORS

Mareike Bierlich, Ingrid Bildstein, Sophie Freitag, Ulrike Michael, Manuela Mild,
Christina Warren

LAYOUT

Soontira Sutanont

PRINTING HOUSE

druckpunkt Tübingen

PHOTO CREDITS

p. 1 Cira Moro, pp.6, 66, 80 Ulrike Essig, p. 28 Alex Hoerner, pp. 34, 99 below Mira Kessler,
pp.42/43 Friedhelm Albrecht/University of Tübingen, p. 72 Südwestmetall/Frank Eppler,
pp. 83, 97 Gudrun de Maddalena, p. 92 Katharina Scheiter/IWM, p. 96 Sebastian Groteloh/
IWM



EBERHARD KARLS
UNIVERSITÄT
TÜBINGEN



LEAD

Graduate School & Research Network