 University of Tübingen IAAT Astronomy	INTEGRAL	Doc: IN-IM-TUB-ICD-01
	IBIS Communication Protocol Definition	Issue: 2.4 Date: JANUARY 1999 
	IMAGER IBIS	Page: 1 of: 27

Title: **IBIS Communication Protocol Definition**

Document No: IN-IM-TUB-ICD-01



Issue: 2.4

Date: JANUARY 1999

Prepared by: R. Volkmer



Checked by:

Approved by:



 University of Tübingen IAAT Astronomy	INTEGRAL	Doc: IN-IM-TUB-ICD-01
	IBIS Communication Protocol Definition	Issue: 2.4 Date: JANUARY 1999 
	IMAGER IBIS	Page: 2 of: 27

Document Change Record

Issue	Date	Sheet	Description of Change
1.0	6.5.1998	all	
2.0 draft	17.6.98	12	Additional HK request protocol (5.3.4-5.3.6)
		17	Context exchanging protocol (6.4.1- 6.4.3)
	3.7.98	7	Timing table
		13	APID is copied by the IASW to internal LSL command
		13	Table 4 update
		14	Table 5 new
		14	Additional HK CID
		15	TID for TC from ground
		16	Command verification
		16	General description of essential HK block
		17	Fig. 6 updated
		17	Fig. 7 updated
		17	Fig. 8 changed
		18	On event message structure
		23	Table handling
		23	Checksum
		25	Table 8 new
		27	Patch and Dump new
2.2	8.07.98	all	Typos
		15	TC from ground to periphery
		24	CRC request command
2.3	30.07.98	6	ISGRI context size (Table 1)
		14	HK block format (5.3.3)
		14	Additional HK Request protocol/command (5.3.4, 5.3.5)
		16	Command verification (5.5)
		17	PICSIT HK size (Figure 8)
		19	Reasons for command rejection: Time out pattern (Figure 12)
		20	Table format: change from variable BL to fixed Block length except the last block.
		21	fixed block length (Table 7)
		25	TC for changing tables in DPE and verification
		26	TM for reporting tables in DPE
			File name: LBR_PR2D.DOC; Last changes: 30.07.98 18:09

 University of Tübingen IAAT Astronomy	INTEGRAL	Doc: IN-IM-TUB-ICD-01
	IBIS Communication Protocol Definition	Issue: 2.4 Date: JANUARY 1999 
	IMAGER IBIS	Page: 3 of: 27

1 References	5
1.1 <i>Applicable documents</i>	5
1.2 <i>Reference documents</i>	5
2 General	5
3 Data rates	5
4 Electrical characteristics	5
4.1 <i>LSL lines:</i>	6
4.2 <i>Address lines</i>	6
4.3 <i>Timing</i>	7
5 Communication Protocol	9
5.1 <i>Command transmission</i>	9
5.1.1 <i>DPE side</i>	9
5.1.2 <i>Sub Instrument</i>	9
5.1.3 <i>End of transmission</i>	9
5.2 <i>Data request protocol</i>	9
5.2.1 <i>DPE</i>	9
5.2.2 <i>Instrument:</i>	10
5.2.3 <i>End of transmission</i>	10
5.3 <i>Command Format</i>	11
5.3.1 <i>Command block format between DPE and periphery</i>	11
5.3.2 <i>Essential HK data Request Commands</i>	12
5.3.3 <i>HK block format:</i>	13
5.3.4 <i>Additional HK request protocol</i>	13
5.3.5 <i>Additional HK request Command</i>	13
5.3.6 <i>Additional HK data block format</i>	13
5.4 <i>General TC from ground to periphery</i>	14
5.4.1 <i>TC Commands from ground</i>	14
5.5 <i>Command verification</i>	15
6 Data exchanging between peripheral sub instruments and IASW or ground	18
6.1 <i>General</i>	18
6.2 <i>Table format</i>	19
6.3 <i>Table numbering</i>	19
6.4 <i>Context exchanging protocol overview</i>	19
6.4.1 <i>Transmit context from periphery to DPE</i>	19
6.4.2 <i>Transmit context from DPE to periphery:</i>	20
6.4.3 <i>Description of checksum algorithm</i>	22
6.5 <i>Formats</i>	22

 University of Tübingen IAAT Astronomy	INTEGRAL	Doc: IN-IM-TUB-ICD-01
	IBIS Communication Protocol Definition	Issue: 2.4 Date: JANUARY 1999 
	IMAGER IBIS	Page: 4 of: 27



6.5.1 Command and data formats between DPE and sub-instruments	22
6.6 Updating tables	24
6.6.1 Changing parameters in the peripheral	24
6.6.2 Changing sub instrument tables in the DPE from ground	24
6.6.3 Writing tables from DPE to periphery	25
6.6.4 Reading instrument tables in the DPE from ground	25
6.6.5 Reading tables from periphery to DPE	26
6.7 Patch and Dump of peripheral memory	26

Table of Figures

Figure 1: Timing of transmitted and received data	7
Figure 2: Organigram	11
Figure 3: LSL command structure	12
Figure 4: Format of additional HK Data request command	13
Figure 5: Additional HK Data block format - sub-instrument to DPE	14
Figure 6: Application data field of TC commands to IBIS periphery (general structure)	15
Figure 7: General essential HK block format structure	16
Figure 8: HK and on event message structure for the different instruments	16
Figure 9: On event message structure	17
Figure 10: Message Class values	17
Figure 11: Message identifier values	18
Figure 12: Reasons for command rejection	18
Figure 13: Message Body (32 bit)	18
Figure 14: Context re-storing in periphery	22
Figure 15: Structure of internal IASW table load command to periphery	22
Figure 16: Format of Data block request command	23
Figure 17: Data block format - sub-instrument to DPE	23
Figure 18: Format of CS request command	24
Figure 19: CS data block format - sub-instrument to DPE	24
Figure 18: Structure of application data field of the TC for changing instrument tables in the DPE	25
Figure 19: Structure of TC for sending instrument tables from DPE to periphery	25
Figure 20: Structure of TC (5,4) for table contents request	25
Figure 21: Structure of TM (5,4) for sending the contents of the instrument tables in the DPE to ground	26
Figure 22: Structure of TC for sending instrument tables from periphery to DPE	26

Table of Tables

Table 1: Required time for saving and restoring of the sub instrument data.	5
Table 2: Instrument address scheme (LSL and address lines) TBC	7
Table 3: Timing of LBR I/F	8
Table 4: HK request commands	13
Table 5: Command ID of additional HK data request command IDs	13
Table 6: Sub Instrument parameter field of on event message (word #1/Bit 0 to 5)	17
Table 7: Table structure	19
Table 8: Examples of the block addresses	23
Table 9: TID and FID of peripheral patch and dump commands	27

 University of Tübingen IAAT Astronomy	INTEGRAL	Doc: IN-IM-TUB-ICD-01
	IBIS Communication Protocol Definition	Issue: 2.4 Date: JANUARY 1999 
	IMAGER IBIS	Page: 5 of: 27

1 References

1.1 Applicable documents

AD1	Integral packet structure definition INT-RP-AI-0030, Is.4, 05/02/98
AD2	Software Interface Control document, INT-IC-GMV-0001, Is. 3.3
AD3	IBIS on board data management user requirement document, TL13453 Is.2

1.2 Reference documents

RD1	User Manual for the IBIS instrument, IN.IB.IAS.UM.001/98
-----	--

2 General

This document describes within the first part the electrical interface of the LBR I/F of IBIS and in the second part the overlaying protocol including command verification.

The DPE LBR I/F has following functions

- transmitting commands for different IBIS sub instruments
- transmitting data (look up tables (LUT), parameter)
- receiving data (HK, LUT)

3 Data rates

The expected data rate is only high when saving/restoring the contents of registers and memory areas of the sub instruments before/after eclipse or for testing.

The maximum transmission rate in the asynchronous mode is 16k baud.

The effective transmission rate is about 9790 bit/sec.



Table 1 shows the required save and restore time for all parameters of the sub instruments.

Instrument	total data to restore [byte]	required restore time [sec]	total data to save [byte]	required save time [sec]
HEPI	28707	23.5	35	0.03
PICSIT	540	0.44	540	0.44
VETO	90	0.07	90	0.07
ISGRI	21056	17.2	21056	17.2
Total	50393	41.2	22386	18.7

Table 1: Required time for saving and restoring of the sub instrument data.

4 Electrical characteristics

The lowest layer (harness) is divided in two main parts, the LSL line (communication) and address lines. Each instrument layer (ISGRI, PICSIT, VETO, HEPI) uses their own LSL line.

 University of Tübingen IAAT Astronomy	INTEGRAL	Doc: IN-IM-TUB-ICD-01
	IBIS Communication Protocol Definition	Issue: 2.4 Date: JANUARY 1999 
	IMAGER IBIS	Page: 6 of: 27

4.1 LSL lines:

- clock (from DPE),
- forward data (from DPE),
- return data (to DPE);

The data link between the units is bi-directional and under control of the DPE. For communication a asynchronous data link control protocol is applied.

Following protocol is used:

- 1 start bit,
- 8 data bit,
- 1 even parity bit,
- 1 stop bit.
- baud rate factor 1x (16 kHz clock frequency will be delivered by the DPE)

The clock line is still used but the DPE programmed frequency is reduced to 16 384 Hz.

Receiving of data are detected by the start bit of the transmitted data word (line goes to zero).

The first byte to be transmitted through the LSL is the most significant byte of the word (understanding that the most significant bit is 0). The LSBit of a byte will be received or transmitted first!

Example: to transmit: 16#1F00#, 16#11FF# this would treated and sent by the LSL driver as follows:

- 1) 1F
- 2) 00
- 3) 11
- 4) FF

Following DPE LSL lines will be used by the instruments:

- 0: HEPI
- 1: PICSIT
- 2: VETO
- 3: ISGRI

4.2 Address lines

HEPI, VETO and PICSIT do not use address lines.

The current address line scheme for the other sub instruments is:

- Address line 0: ISGRI
- 1: ISGRI
- 2: not used
- 3: not used
- 4: ISGRI

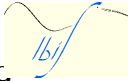
 University of Tübingen IAAT Astronomy	INTEGRAL	Doc: IN-IM-TUB-ICD-01
	IBIS Communication Protocol Definition	Issue: 2.4 Date: JANUARY 1999 
	IMAGER IBIS	Page: 7 of: 27

- 5: ISGRI
- 6: not used
- 7: OMC DPE (not used)

LSL	LSL	ADD 5	ADD 4	ADD 3	ADD 2	ADD 1	ADD 0	Decimal number	Instrument
MSB _i	1	2	3	4	5	6	LSB _i 7		
0	0	0	0	0	0	0	0	0	HEPI
0	1	0	0	0	0	0	0	64	PICSI FDM
1	0	0	0	0	0	0	0	128	VETO
1	1	0	0	0	0	1	0	194	ISGRI MCE 1
1	1	1	0	0	0	1	0	226	ISGRI MCE 2
1	1	0	1	0	0	1	0	210	ISGRI MCE 3
1	1	1	1	0	0	1	0	242	ISGRI MCE 4
1	1	0	0	0	0	0	1	193	ISGRI MCE 5
1	1	1	0	0	0	0	1	225	ISGRI MCE 6
1	1	0	1	0	0	0	1	209	ISGRI MCE 7
1	1	1	1	0	0	0	1	241	ISGRI MCE 8

Table 2: Instrument address scheme (LSL and address lines) TBC

4.3 Timing

The DPE sends commands to periphery with or without parameters. Receiving of data are detected by the start bit of the transmitted data word (line goes to zero). Figure 1 show the timing of the transmitted and received data with respect to the clock line.

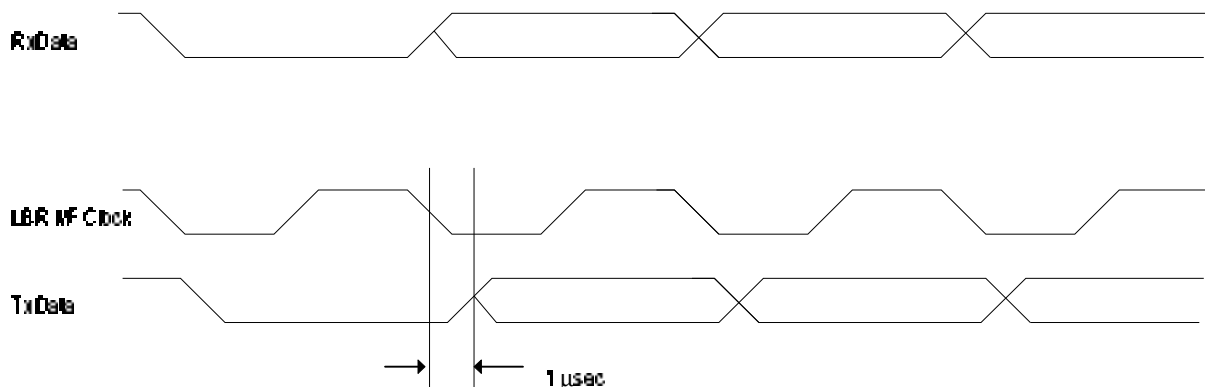



Figure 1: Timing of transmitted and received data

- T1: Delay between end of transmission of 8 bits and start of transmission of the next one included in the same block (from sub instrument to DPE and from DPE to sub instruments)
- T2: Delay from end of HK request reception by instrument from DPE and HK block

 University of Tübingen IAAT Astronomy	INTEGRAL	Doc: IN-IM-TUB-ICD-01
	IBIS Communication Protocol Definition	Issue: 2.4 Date: JANUARY 1999 
	IMAGER IBIS	Page: 8 of: 27

transmission by instrument to DPE

T3: Time gap between two successive commands



T4: Delay from end of HK data block transmission by instrument and next command
 Block or HK request by DPE to instrument

T5: Delay from end of CS request receipt by instrument from DPE and CS transmission by
 instrument to DPE

The times below must be confirmed by the instruments!

ID	Min. time[msec]	Max. time [msec]	
T1	0	1	
T2	0	10	
T3	10	no limit	
T4	0	no limit	
T5	0	250	

Table 3: Timing of LBR I/F

 University of Tübingen IAAT Astronomy	INTEGRAL	Doc: IN-IM-TUB-ICD-01
	IBIS Communication Protocol Definition	Issue: 2.4 Date: JANUARY 1999 
	IMAGER IBIS	Page: 9 of: 27

Notes:

- I. IASW hands only the complete command/data block to CSSW and then CSSW activate the transmission to the instrument. The buffers of the DPE/CSSW are 16 bit word organised. Therefore it is not possible to send a single byte.
- II. Only after a dedicated command the sub instrument puts data within a TBD time on the line. The number of bytes are defined due to the previous command.

5 Communication Protocol

The communication protocol of transmission differs for commands with and without data request.

5.1 Command transmission

5.1.1 DPE side

DPE starts the communication with

- selection of LSL line (0..3)
- and selection of the address lines (only ISGRI)
- Start of transmission with sending the first command block on the data forward line
- only one command at each transmission

5.1.2 Sub Instrument

- wait and receive a complete block (length measured in 16 bit words = first byte)
- checks the parity of each byte
- verifies the length
- checks if it is a HK or data request
- if valid the instrument executes the command and increases the internal counter of executed commands
- if not valid generated an on event message and increases the internal counter for rejected events

5.1.3 End of transmission

- After transmission DPE CSSW deselects the address and LSL lines
- No retry in case of command rejection by periphery

5.2 Data request protocol

This protocol is used for exchanging data (HK, parameters etc.) from instrument to the DPE

5.2.1 DPE

- Selecting the dedicated LSL line (0 to 3)

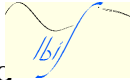
 University of Tübingen IAAT Astronomy	INTEGRAL	Doc: IN-IM-TUB-ICD-01
	IBIS Communication Protocol Definition	Issue: 2.4 Date: JANUARY 1999 
	IMAGER IBIS	Page: 10 of: 27

- Selecting the dedicated address lines (only ISGRI)
- Start of transmission with sending the data request

5.2.2 Instrument:

- wait and receive a complete block (length = first byte)
- checks the parity of each byte
- verifies the length
- checks if it is a data request
- if not valid generated an on event message and increases the internal counter for rejected events
- sends the data within TBD time (T2)

5.2.3 End of transmission

- DPE waits a TBD time for receiving the HK data
- parity check
- length check
- if not valid (or time out) DPE generate on event message
- after receiving data DPE deselects the address and LSL lines
- No retry in case of command rejection by periphery

 University of Tübingen IAAT Astronomy	INTEGRAL	Doc: IN-IM-TUB-ICD-01
	IBIS Communication Protocol Definition	Issue: 2.4 Date: JANUARY 1999
	IMAGER IBIS	Page: 11 of: 27

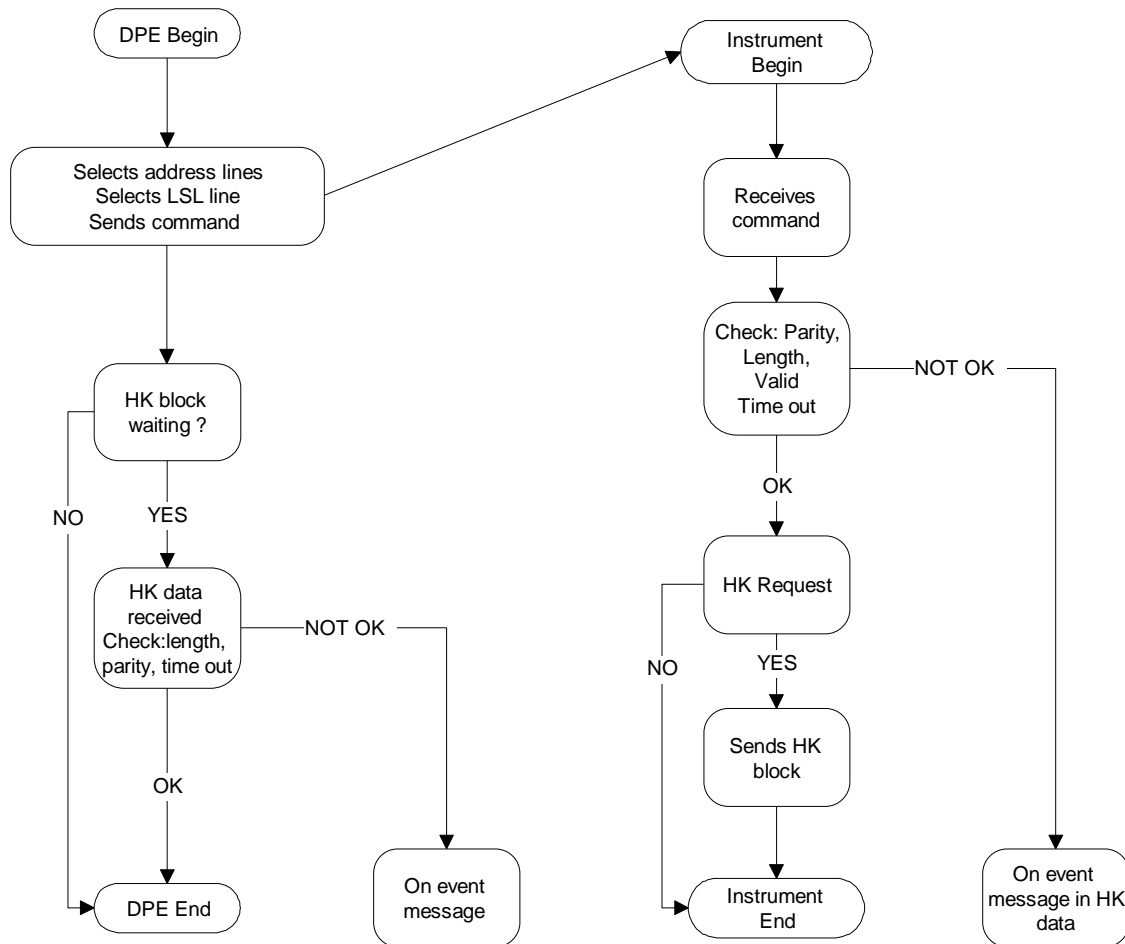

Figure 2: Organigram

5.3 Command Format

Commands could be generated on ground or within the DPE.

The IASW receives TC and distributes them to the periphery.

Note: There exists no specific Application ID of the periphery.



5.3.1 Command block format between DPE and periphery

All internal data exchanges between DPE and periphery should have even numbers of bytes.

The first transmitted byte of a data block contains the length of the block in 16-bit words!

Word #1/Byte #1: block length (range: 1..120 word (16 bit)) of the complete command block

Word #1/Byte #2: command ID of the peripheral command. The operator code should

 University of Tübingen IAAT Astronomy	INTEGRAL	Doc: IN-IM-TUB-ICD-01
	IBIS Communication Protocol Definition	Issue: 2.4 Date: JANUARY 1999 
IMAGER IBIS		Page: 12 of: 27

not exceed 1 byte (ref. Figure 3).

Word #2/Byte #3: APID: The APID (bit 3 to bit 10) of the IASW (nominal or redundant) which is sending the command.

Word #2/Byte #4: SUB ID: The Instrument Sub Address of the receiver (ref. Table 2).

Word #3/Byte #5..6: Packet Sequence Control (PSC).
 Bit 0 ..1: set to "11"
 Bit 2: 0 for commands from ground
 1 for on board commands
 Bit 3 ..15: Sequence counter of commands related to APID (for on ground generated commands) and sub instrument address (only for on ground generated commands).

Word #4 ..N: parameter field if required. The parameter field should have an even number of bytes.

Byte	#1	#2	#3	#4	#5	#6	#7 .. n
Word	#1	#2		#3		#4 ... N	
Commands without parameter	Length	Command ID	APID	SUB ID	PSC (MSByte)	PSC (LSByte)	
Commands with parameter	Length	Command ID	APID	SUB ID	PSC	PSC	parameter field

Figure 3: LSL command structure

5.3.2 Essential HK data Request Commands

The IASW could generate the internal commands requesting the essential HK data from the periphery.

The command for essential HK data request could be different for each sub instrument and is stored within a table of IASW.

The length of the request command ID field should not exceed one byte. Table 4 shows the HK request commands of the different sub instruments.

Sub Instrument	Byte #1	Byte #2	Byte #3	Byte #4	Byte #5 .. #6
	Length	Command ID	APID	SUB ID	PSC
HEPI	3	118	1281 or 1409	00	49152 .. 65535
PICSI	3	167	1281 or 1409	64	49152 .. 65535
VETO	3	131	or 1281 or 1409	128	49152 .. 65535
ISGR	3	254	1281 or 1409	194 to 241	49152 .. 65535



 University of Tübingen IAAT Astronomy	INTEGRAL	Doc: IN-IM-TUB-ICD-01
	IBIS Communication Protocol Definition	Issue: 2.4 Date: JANUARY 1999 
	IMAGER IBIS	Page: 13 of: 27

Table 4: HK request commands

5.3.3 HK block format:

On request the sub instruments sends to DPE the HK data block. The general structure of the HK data is defined as:

first byte (all): block length (range: 1 ..214 word)

second byte: CID:

third to n-th byte: HK data

For more details ref. Figure 8 and the individual SW periphery descriptions.

5.3.4 Additional HK request protocol

On request the sub instruments sends to DPE the additional HK data block.

- DPE choose the relevant LSL line
- DPE sends N-times (N is (size of HK block + 127)/128) the data request command of block[N]

For the polling rate for each sub system refer RD1.

5.3.5 Additional HK request Command

For exchanging the additional HK data between periphery and DPE the format of the request command should be the same (except the CID, Figure 4) .

The start address of the addition HK data is for the first block 0. If there is more than 1 data block, the address increases by 128 each block.

Byte							
1	2	3	4	5	6	7	8
Length	CID	APID	SUB ID	PSC	PSC	(MSB)-(LSB) address	

Figure 4: Format of additional HK Data request command

Table 5 shows the additional HK data request commands Ids of the different sub instruments.

Sub Instrument	CID	
PICSIT	0xA2	
ISGRI	0xFD	
VETO	0x09	

Table 5: Command ID of additional HK data request command IDs

5.3.6 Additional HK data block format

The additional HK data block format is shown in Figure 5.

Byte							
1	2	3	4	5	6	BL+4
Length	CID	(MSB)-(LSB) address		Data	Data	Data	Data



 University of Tübingen IAAT Astronomy	INTEGRAL	Doc: IN-IM-TUB-ICD-01
	IBIS Communication Protocol Definition	Issue: 2.4 Date: JANUARY 1999 
	IMAGER IBIS	Page: 14 of: 27

Figure 5: Additional HK Data block format - sub-instrument to DPE

5.4 General TC from ground to periphery

Sending commands from ground (or generated within the CDMU) to the periphery means, to use the IASW APID. This is 1281 of IBIS DPE (nominal) and 1409 (redundant).

Each receiver could be identified by his LSL number and address lines. (ref. Table 2

To distribute the commands, a special tasks within the IASW is used.

The task ID of this IASW task is TBD.

Each command, which should be send directly to the periphery without processing by the IASW (only command handling) should be a TC (5,3) Load task parameter with a APID 1281 (nominal DPE) or 1409 (redundant DPE).

The APID and PSC is copied by the IASW to the data field. Only the contents from word #3 o the end of the data field is handed over to the periphery via LBR I/F. The other fields are used to identuify the receiver and the requested data length.

The verification is done in VC 0 TM packets, by on event messages or TM (5,4) packets.

The on event buffer could also be read out from ground by request.

5.4.1 TC Commands from ground

The APID, the TID and the FID defines unique the structure of the TC.

Word #1/Byte #1: The TID is different for each sub instruments layer

192: HEPI

193: PICSIT

194: VETO

195: ISGRI

Word #1/Byte #2: The FID is identical to the command ID (word #3/byte #2) but for ISGRI the FID is a combination of command ID and MCE number (e.g. bit 0 .. 2) and the command ID (e.g. bit 3 to 7).

Word #2/Byte #1: The length of the requested data block from the periphery. If the length is 0 no data are sent back to ground.

If the length is greater than 0 the IASW is waiting for the number of data blocks sends from the periphery back to the IASW. The data are packed into TM(5,4) packets and send down to ground. The format of the TM packets depends only from the TID and FID and corresponds to the internal command ID. This data are only send back for diagnostic purposes (e.g. direct control of parameter settings).



Word #2/Byte #2: This field should be filled with the instrument address (ref. Table 2).

The contents from Word #3 to the end of the parameter field (grey shaded in Figure 6) of the TC has the same structure as the internal commands (ref. Figure 3).

Word #3/Byte #1: The length is the number of data in 16 bit-word send to the periphery.

Word #3/Byte #2: command ID of the periphery command.

Word #4/Byte #1: Left blank from ground. The IASW put here the APID from the TC

 University of Tübingen IAAT Astronomy	INTEGRAL	Doc: IN-IM-TUB-ICD-01
	IBIS Communication Protocol Definition	Issue: 2.4 Date: JANUARY 1999 
	IMAGER IBIS	Page: 15 of: 27

Word #4/Byte #2: Left blank from ground. The IASW put here the sub instrument address

Word #5/Byte #1,2: Left blank from ground. The IASW put here the Packet sequence control.

Word #6 to N: Parameters if required

The general structure of the application data field of the TC is shown in Figure 6.

	M															LS	
Bit No.	SB	0	1	2	3	4	5	6	7	8	9	10	11	12	13	14	B
		Byte #1								Byte #2							
Word #1		Task ID								FID							
Word #2		Data Request Length								Sub Instrument Address							
Word #3		Internal Command Length								Command ID							
Word #4		APID								SUB ID							
Word #5		PSC															
Word #6		Parameter 1															
Word #N		Parameter n															



Figure 6: Application data field of TC commands to IBIS periphery (general structure)

5.5 Command verification

The IASW checks if the TID exists and extract then the internal part of the command and put it on the LSL. The sub instruments checks the command again by syntax and structure. If the command is valid it will be executed and a counter for executed commands are increased. If the command is not valid the command will be rejected and a counter of rejected commands is increased. Also on on event message will be genreated to identify the command and the reason for rejection. The on event message is put in the on event message buffer of the subsystem.

The content of the on event message buffer is appended to the standard HK data block from the periphery to DPE. The on event message field of the HK data block has a constant length of eighth on event messages for each sub instrument The DPE verifies the on event message extension of the HK data of each sub instrument and copies the messages to the relevant on event message fields within the CSSW/IASW HK TM (ref. AD2). The size of the on event buffer of the CSSW is 64 messages. This buffer is emptied each 8 sec by eight on event messages. If the buffer is filled the on event messages will be rejected until the buffer is emptied again.

The structure of the on event message field is according AD1(3.2.8) except the on event message timing information, which is automatically generated and inserted by the CSSW (ref. AD 2). The length of one on event message field is therefore 3 word. The on event message structure is shown in Figure 9 (ref. also AD1, 3.2.8).

 University of Tübingen IAAT Astronomy	INTEGRAL	Doc: IN-IM-TUB-ICD-01
	IBIS Communication Protocol Definition	Issue: 2.4 Date: JANUARY 1999 
	IMAGER IBIS	Page: 16 of: 27

The general structure of the on essential HK and on event extension is shown in Figure 7. The parameter **n** is the number of bytes of the essential HK data (including length and CID byte). The descriptions of the different instruments is listed in Figure 8. The first two bytes after the standard HK contains the ON event message counter. This counter counts the valid on event messages within the message field.

The on event message field is distributed with **each** essential HK Data block to the DPE. If no message was generated the on event counter remains zero and the message identifier of each field is 255. The length of each peripheral HK data block is therefore constant.

Byte No	Description
1	length (n+50) /2
2	CID
3 to n	data
n+1 and n+2	on event message counter
n+3 to n+8	on event message 1
n+9 to n+14	on event message 2
n+15 to n+20	on event message 3
n+21 to n+26	on event message 4
n+27 to n+32	on event message 5
n+33 to n+38	on event message 6
n+39 to n+44	on event message 7
n+45 to n+50	on event message 8

Figure 7: General essential HK block format structure

	Standard HK Byte from /to	On Event Message counter	On Event Message fields #1 to #8 from /to
HEPI	1/34	35/36	37/84
PICSIT	1/86	87/88	89/136
VETO	1/40	41/42	43/90
ISGRI (MCE 1..8)	1/12	13/14	15/62



Figure 8: HK and on event message structure for the different instruments

Each instrument can transmit not more than 8 on event message in one HK data packet.

An empty slot will be identified setting the Message Identifier field to 255.

After reading out the HK data block the transmitted on event messages are deleted in the sub instrument.

MS Bit																LS Bit	
0	1	2	3	4	5	6	7	8	9	10	11	12	13	14	15		
Sub Instrument parameter						Class		Message Identifier								Word #1	

 University of Tübingen IAAT Astronomy	INTEGRAL	Doc: IN-IM-TUB-ICD-01
	IBIS Communication Protocol Definition	Issue: 2.4 Date: JANUARY 1999 
	IMAGER IBIS	Page: 17 of: 27

Message Body	Word #2
Message Body	Word #3

Figure 9: On event message structure

The sub instrument parameter field (word #1/Bit 0 to 5) of the on event message is filled by the periphery with parameters to identify the source of the message (e.g. ISGRI: MCE channel).

HEPI	100 000
PICSIT	101 000
VETO	110 000
ISGRI MCE#1	111 000
ISGRI MCE#2	111 001
ISGRI MCE#3	111 010
ISGRI MCE#4	111 011
ISGRI MCE#5	111 100
ISGRI MCE#6	111 101
ISGRI MCE#7	111 110
ISGRI MCE#8	111 111

Table 6: Sub Instrument parameter field of on event message (word #1/Bit 0 to 5)

Word #1/Bit 6 to 7 identifies the message class. Figure 10 lists valid message classes. For TC verification class 3 should be used.

Message Class Value	Message Class description
0	Events (non critical events)
1	Exception (non fatal anomaly)
2	Major Anomaly (serious anomaly)
3	Rejected/failed Telecommand Packet Reports

Figure 10: Message Class values

The valid message ID (word #1/bit 8 to 15) range is from 128 to 254. The range from 0 to 127 is reserved for CSSW. The value 255 is reserved to identify an empty message slot.

Figure 11 shows the allocation of the Message ID range to the different sub instruments.

The 'x' could be defined by the sub instruments according Figure 12 and individual need..

	Message ID range	Bin value
IASW	128/151	100xxxxx
HEPI	152/159	10011xxx
PICSIT	160/175	1010xxxx
VETO	176/191	1011xxxx
ISGRI (MCE #1)	192/199	11000xxx
ISGRI (MCE #2)	200/207	11001xxx

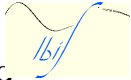
 University of Tübingen IAAT Astronomy	INTEGRAL	Doc: IN-IM-TUB-ICD-01
	IBIS Communication Protocol Definition	Issue: 2.4 Date: JANUARY 1999 
IMAGER IBIS		Page: 18 of: 27

ISGRI (MCE #3)	208/215	11010xxx
ISGRI (MCE #4)	216/223	11011xxx
ISGRI (MCE #5)	224/231	11100xxx
ISGRI (MCE #6)	232/239	11101xxx
ISGRI (MCE #7)	240/247	11110xxx
ISGRI (MCE #8)	248/254	11111xxx

Figure 11: Message identifier values

The last bits of the message ID identify the reason for generating the message. For the rejected/failed telecommand package message class at least following reasons for command acceptance failure have to be implemented:

Bin value (Bit 13 to 15)	Reason
xxxxx000	Illegal command number
xxxxx001	Parity error
xxxxx101	Illegal length
xxxxx110	Time out

Figure 12: Reasons for command rejection

The first bits depends on the sub instrument Message ID.

The message body in Figure 13 contains for rejected/failed telecommands, the internal command ID, APID of the source of the command (nominal or redundant DPE/IASW) and the PSC of the rejected command. Bit 0 to 1 of the PSC is set to "00" by the sub instrument. The Source Src (Bit 2) identifies if the command was generated on ground (0) or on board (1).

MS Bit																LS Bit
0	1	2	3	4	5	6	7	8	9	10	11	12	13	14	15	
CID								APID								
"00"	Src	Sequence counter														

Figure 13: Message Body (32 bit)

6 Data exchanging between peripheral sub instruments and IASW or ground



6.1 General

In case of eclipse the instruments are powered off but the DPE is still on. So the IBIS IASW is able to hold images of all sub instrument contexts (parameters, tables, etc.) within the memory of DPE.

These images or contexts are called further on tables.

This requires a simple and uniform management of these tables. So we propose the following management scheme.

Each sub-instrument gets only one table in the DPE memory.

 University of Tübingen IAAT Astronomy	INTEGRAL	Doc: IN-IM-TUB-ICD-01
	IBIS Communication Protocol Definition	Issue: 2.4 Date: JANUARY 1999 
	IMAGER IBIS	Page: 19 of: 27

In case of PICSIT, VETO and ISGRI the periphery is the master of the tables. So each parameter update is done in the periphery. Only in case of HEPI the IASW holds the master tables.

E.g. ISGRI gets 8 tables (8 for MCEs).

These tables should contain all parameters.

The context storage in the periphery depends on the sub instruments.

6.2 Table format

The tables of the sub-instrument images in the DPE is divided into separate blocks (ref. Table 7). The block length (BL) is normally 64 word, but the last block could be different.

This simplify the upload of the data for the sub-instrument SW and guarantee the optimal utilisation of the DPE memory space.

The table size is therefore also variable, but the maximum required number of blocks must be known before compiling the IASW. IASW/CSSW is not able to allocate memory dynamically.

Table number	Length of block (BL, 1..64)	Block number (1 .. max.)	Data block (128 byte)
	64	1	
	64	2	
	64	3	
	64	4	
	64	5	
	64	...	
	64..	...	
	< 65	max.	

Table 7: Table structure

6.3 Table numbering



Each table is identified by the table number (Tb ID) which is identical to the sub instrument number (LSL number and address line, 2 bit for instrument LSL line and 6 bit for the address lines, ref. Table 2).

6.4 Context exchanging protocol overview

6.4.1 Transmit context from periphery to DPE

Send autonomously one request command for each context block to sub-instruments

- DPE choose the relevant LSL line
- DPE sends N-times (N is (size of context+127)/128) the data request command of block[N]
- After transmitting the data DPE send request command for checksum of the context.
- DPE receives this checksum in TBD time (this depends, how fast the periphery could calculate the CS)
- DPE compares this value with its own checksum calculation:

 University of Tübingen IAAT Astronomy	INTEGRAL	Doc: IN-IM-TUB-ICD-01
	IBIS Communication Protocol Definition	Issue: 2.4 Date: JANUARY 1999 
	IMAGER IBIS	Page: 20 of: 27

- If correct, the context restore flag (CRF) in IASW HK data will be set
- otherwise an on event message generated

6.4.2 Transmit context from DPE to periphery:

Transfer of the complete tables from DPE to each sub-instrument. During transfer the tables are divided in separate data blocks.

- DPE choose the relevant LSL line
- DPE sends N-times (N is $(\text{size of context} + 127) / 128$) a data block[N].
- After transmitting the data DPE send request command for CS of the context.
- DPE receives this checksum in TBD time (this depends, how fast the periphery could calculate the CS)
- DPE compares this value with its own checksum calculation:
 - If correct, the context save flag (CSF) in IASW HK data will be set
 - otherwise an on event message generated

 University of Tübingen IAAT Astronomy	INTEGRAL	Doc: IN-IM-TUB-ICD-01
	IBIS Communication Protocol Definition	Issue: 2.4 Date: JANUARY 1999
	IMAGER IBIS	Page: 21 of: 27

D:\INTEGRAL\PLOTS\table_hand.abc

Freitag, 29. Mai 1998

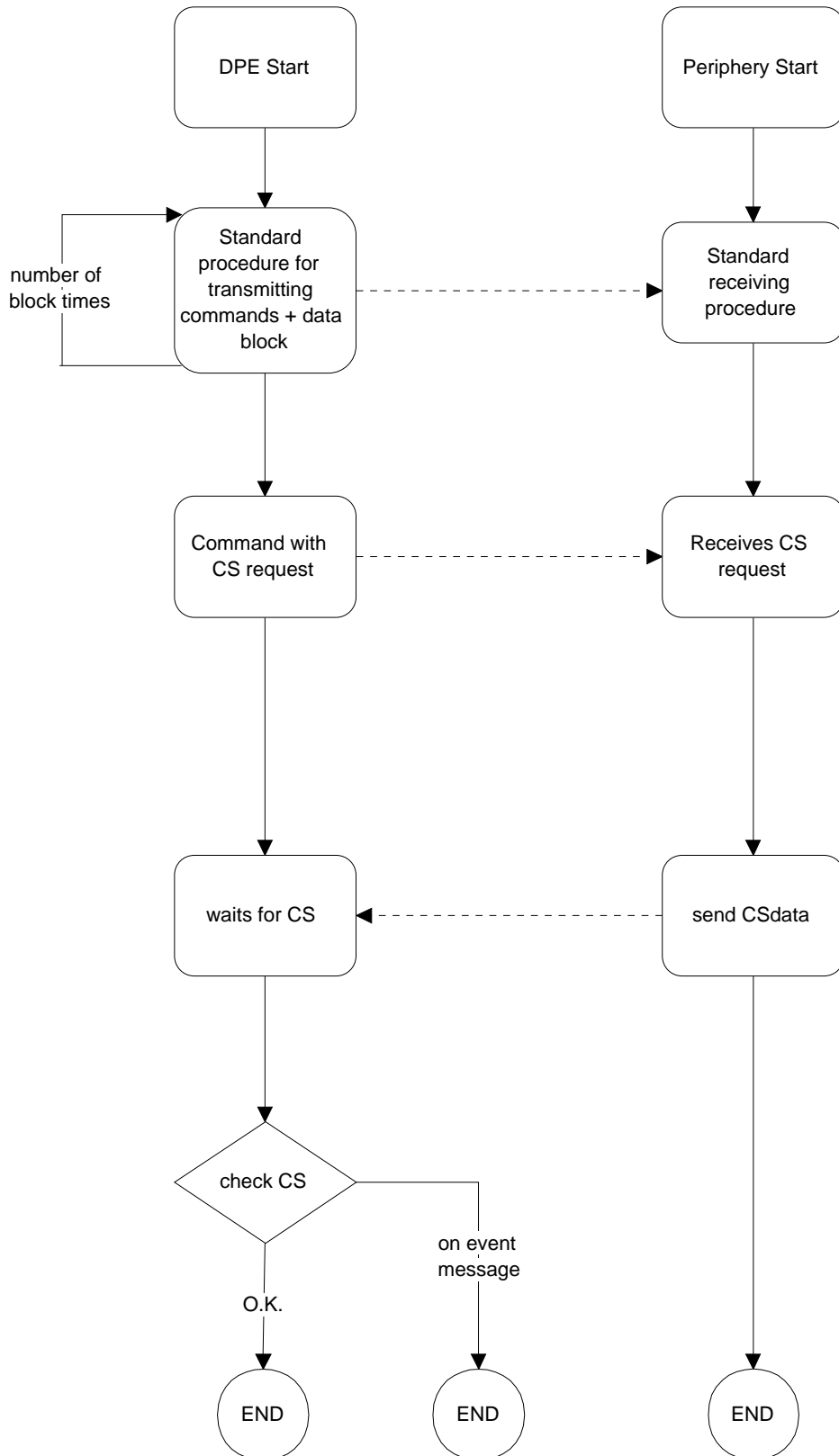



 University of Tübingen IAAT Astronomy	INTEGRAL	Doc: IN-IM-TUB-ICD-01
	IBIS Communication Protocol Definition	Issue: 2.4 Date: JANUARY 1999 
	IMAGER IBIS	Page: 22 of: 27

Figure 14: Context re-storing in periphery

The communication protocol requires a checksum request command to the periphery. Because DPE has to know, if the context is restored correctly in the periphery, IASW compares the checksums in both cases, save and restore.

The command numbers (CID) for updating the table within the sub-instrument, could be individual for each instrument and stored also within tables of the IASW.

6.4.3 Description of checksum algorithm

The checksum (CS) is a 16 bit word and the negative modulo 2^{16} of the sum of all data words. It is calculated from the whole context data.

The algorithm:

```

CS=0
for i=0,n-1 do
    CS=CS+word(i)
end for
CS= - (CS mod (216 - 1))
  
```

where n is the number of data words.

6.5 Formats

6.5.1 Command and data formats between DPE and sub-instruments

The following formats are applicable for the communication between DPE and sub-instruments.

Each data block from Table 7 (one row) is sent separately to the periphery.

The structure of the transmitted block from DPE to sub-instrument is shown within Figure 15.

Byte											
1	2	3	4	5	6	7	8	9	10	BL+8
Length	CID	APID	SUB ID	PSC	PSC	(MSB)	(LSB)	Data	Data	Data	Data
						address					



Figure 15: Structure of internal IASW table load command to periphery

The 1st to 6th bytes contains the command header to load the block (ref. Figure 3 for the structure) and the 7th and 8th byte the correct address of the parameter block within the periphery.

The address is calculated as
for i=1 to max_number_of_blocks .

```

begin
    address=block_number(i-1)*128
  
```

 University of Tübingen IAAT Astronomy	INTEGRAL	Doc: IN-IM-TUB-ICD-01
	IBIS Communication Protocol Definition	Issue: 2.4 Date: JANUARY 1999 
	IMAGER IBIS	Page: 23 of: 27

end

Table 8 shows examples of the addresses of the first blocks.

Block Number	Address: MSB	Address: LSB
1	0x00	0x00
2	0x00	0x80
3	0x01	0x00
4	0x01	0x80
5	0x02	0x00
6	0x02	0x80
7	0x03	0x00
8	0x03	0x80
9	0x04	0x00
10	0x04	0x80
11	0x05	0x00
12	0x05	0x80

Table 8: Examples of the block addresses

To read the blocks from the periphery in to the IASW a request command is needed (Figure 16). Each data block from the sub-instrument is read separately. The addresses are generated as described above.

Byte							
1	2	3	4	5	6	7	8
Length	CID	APID	SUB ID	PSC	PSC	(MSB)-(LSB) address	

Figure 16: Format of Data block request command



The structure of the data format between sub-instrument and DPE is shown in Figure 17. The CID in this structure is the command ID of the request command.

Byte							
1	2	3	4	5	6	BL+4
Length	CID	(MSB)-(LSB) address		Data	Data	Data	Data

Figure 17: Data block format - sub-instrument to DPE

Figure 18 shows the structure of the checksum request command. The CID is 0xFB (HEX) for all instruments.

Byte					
1	2	3	4	5	6

 University of Tübingen IAAT Astronomy	INTEGRAL	Doc: IN-IM-TUB-ICD-01
	IBIS Communication Protocol Definition	Issue: 2.4 Date: JANUARY 1999 
	IMAGER IBIS	Page: 24 of: 27

3	0xFB	APID	SUB ID	PSC	PSC
---	------	------	-----------	-----	-----

Figure 18: Format of CS request command

The structure of the CS data block between sub-instrument and DPE is shown in Figure 19. The CID in this structure is the command ID of the CS request command.

Byte			
1	2	3	4
2	0xFB	(MSB) (LSB) CS	

Figure 19: CS data block format - sub-instrument to DPE

6.6 Updating tables

6.6.1 Changing parameters in the peripheral

To change a parameter of an instrument from ground, one or more TC (5,3) including the data is sent to the peripheral instrument. (ISGRI, PICSIT, VETO, HEPI).



The IASW unpacks the TC and sent the internal commands to the peripheral.

For the structure of the TC refer Figure 3. A detailed definition of the internal commands is given in the individual descriptions of the peripheral instruments.

6.6.2 Changing sub instrument tables in the DPE from ground

To change the contents of the stored table of a sub instrument in the DPE, a TC(5,3) load task parameter is sent from ground to the IASW table handling task. The structure of the TC is shown Figure 20.

b0	b1	b2	b3	b4	b5	b6	b7	b8	b9	b10	b11	b12	b13	b14	b15
TID (TID)								FID = Table ID (same as instrument address ref. Table 2)							
first block number								first block length							
word #1															
.....															
word #(first block length)															
second block number								second block length							
word #1															
.....															
word #(second block length)															
third block number								second block length							
word #1															
.....															
word #(second block length)															
.....															
word #212: 0															
block number								block length							

 University of Tübingen IAAT Astronomy	INTEGRAL	Doc: IN-IM-TUB-ICD-01
	IBIS Communication Protocol Definition	Issue: 2.4 Date: JANUARY 1999 
	IMAGER IBIS	Page: 25 of: 27

word #1	
.....	
word #(length)	

Figure 20: Structure of application data field of the TC for changing instrument tables in the DPE

The task ID (TID) is described in RD1. The FID is set to the instrument table number (Tb ID, ref. Table 2)

For the definition of the block number refer 6.3.

After updating the table a TM(5,4) packet is send with the same parameter as uplinked. The structure is the same as in Figure 23.

Note: The same structure (but with different TID and FID) is also used by the IASW to change internal tables.

6.6.3 Writing tables from DPE to periphery

A TC (5,1) start task could be send to the IASW to initiate sending sequentially all data blocks via the LBR to the periphery. The updating scheme depends on the sub instrument.

The structure of the TC is shown Figure 21.

b0	b1	b2	b3	b4	b5	b6	b7	b8	b9	b10	b11	b12	b13	b14	b15
TID (TBD)								FID (instrument address ref. Table 2)							

Figure 21: Structure of TC for sending instrument tables from DPE to periphery

After receiving the TC the appropriate commands (refer chapter 6.5.1) are sent to the periphery.

6.6.4 Reading instrument tables in the DPE from ground

The contents of each table within the DPE could be read out with an report task parameter TC(5,4). The structure is shown in Figure 22.



b0	b1	b2	b3	b4	b5	b6	b7	b8	b9	b10	b11	b12	b13	b14	b15
TID (TBD)								FID (instrument address ref. Table 2)							

Figure 22: Structure of TC (5,4) for table contents request

The task ID (TID) is defined in RD1. The FID is set to the instrument number (ref. Table 2)

Then the task generates task parameter report packets TM (5,4). Each TM could contain at most 3 blocks. The structure is shown in Figure 23. If the second and/or third block are not used the block number and the block length should be set to 0.

b0	b1	b2	b3	b4	b5	b6	b7	b8	b9	b10	b11	b12	b13	b14	b15
TID (TBD)								FID (instrument address ref. Table 2)							
first block number								first block length							
word #1															
.....															

 University of Tübingen IAAT Astronomy	INTEGRAL	Doc: IN-IM-TUB-ICD-01
	IBIS Communication Protocol Definition	Issue: 2.4 Date: JANUARY 1999 
	IMAGER IBIS	Page: 26 of: 27

word #(first block length)	
second block number	second block length
word #1	
.....	
word #(second block length)	
third block number	second block length
word #1	
.....	
word #(second block length)	
.....	
word #212: 0	

Figure 23: Structure of TM (5,4) for sending the contents of the instrument tables in the DPE to ground

Note: The same structure (but with different TID and FID) is also used by the IASW to report internal tables.

6.6.5 Reading tables from periphery to DPE

A TC (5,1) start task could be send to initiate the IASW to save the context of the sub instruments in the DPE-Memory via LBR I/F.

b0	b1	b2	b3	b4	b5	b6	b7	b8	b9	b10	b11	b12	b13	b14	b15
TID (TBD)								FID (instrument address ref. Table 2)							

Figure 24: Structure of TC for sending instrument tables from periphery to DPE

Then the appropriate command sequence (refer chapter 6.5.1) will be sent to the periphery.

6.7 Patch and Dump of peripheral memory

To patch or dump of the peripheral SW individual commands are required.

The command structure is equal as for all other commands from ground with data request (ref. 5.4.1).



TC (5,3) commands are used to dump data from the periphery. The data are packetised into TM(5,4) packages by IASW and send to ground.

The TID are defined in the 5.4.1. The function ID depends on the sub instrument.

VETO and PICSIT have to change their mode before receiving dump/patch commands.

To HEPI dump and patch is not applicable, because HEPI has no SW.

Patch TID_FID	Dump TID_FID	Instrument
193_168	193_170	PICSIT
194_160	194_192	VETO
195_22	195_31	MCE 1
195_54	195_63	MCE 2

 University of Tübingen IAAT Astronomy	INTEGRAL	Doc: IN-IM-TUB-ICD-01
	IBIS Communication Protocol Definition	Issue: 2.4 Date: JANUARY 1999 
	IMAGER IBIS	Page: 27 of: 27

195_86	195_95	MCE 3
195_118	195_127	MCE 4
195_150	195_159	MCE 5
195_182	195_191	MCE 6
195_214	195_223	MCE 7

Table 9: TID and FID of peripheral patch and dump commands